

April 4, 2018

ERI Project No.: 0807#0696

Mr. Tyler Brown, Program Manager
Department of Natural Resources & Environmental Control
Wetlands & Subaqueous Lands Section
89 Kings Highway
Dover, Delaware 19901-7305

Re: Oyster House Village Community Dock
Tax Map Parcel 334-19.00-173.00 Lands of the United States of America
Lewes & Rehoboth Hundred, Sussex County, Delaware
Waterway: Lewes-Rehoboth Canal
Applicant: OHV DE, LLC. Attn: Mr. Kevin Delaney

APR 10 2018

gc

Dear Mr. Brown,

Environmental Resources, Inc. (ERI), is submitting the enclosed application for a Marina Permit, Subaqueous Lands Permit, and Water Quality Certificate for a 520 foot long community dock to be located along the westerly shoreline of the Lewes-Rehoboth Canal. The project site begins 700 feet south of the Delaware State Route One highway bridge over the Canal. The project site is located on lands owned by the United States of America managed by the U.S. Army Corps of Engineers (Corps) Real Estate Division located in the Baltimore District. Pre-Application discussions about the project have occurred with that office and with the Philadelphia District Operations Division. The design and scope of the proposed project have been guided by those discussions. In addition, consultation with the Delaware Department of Natural Resources and Environmental Control (DNREC) Waterway Management Program has also occurred. DNREC maintains lease for a small storage compound to facilitate their dredging operations also at this location. ERI and the applicant have reached a preliminary agreement about relocating and expanding the storage compound as shown on the enclosed plans with Mr. Chuck Williams and Mr. Scott Figurski of that office. DNREC will also be permitted to seasonally use the northern portion of the proposed dock for mooring during their active dredging season.

Upon review of the project by the Corps Operations Division, Real Estate Section, and your office; the applicant and DNREC will seek new leases from the Corps to allow for the uses of government property as proposed herein.

DRAFT

The applicant is the owner and developer of the adjacent land, Tax Map Parcel 334-19.08-42.00 where a single family home community consisting of 30 units is approved. As is the case with other areas along the Lewes-Rehoboth Canal, the proposed project and Corps lease will provide recreational water access for these residents.

As discussed, the project will provide DNREC's Waterway's Management Section with an improved facility which includes fire protection at the dock. The project also addresses the serious problem of bank erosion which is especially severe on the southern portion of the property. Redevelopment of this site will also remove deteriorated docks and pilings remaining from the past use of the site as an oyster processing facility.

The details of the project are explained in the enclosed permit application. I am also enclosing full size project plans in addition to 8 1/2" x 11" permit drawings. Also enclosed are the application fee, O&M Plan approval fee and the public notice fee.

An application for a Coastal Zone Consistency Determination has also been filed with DNREC's Coastal Management Program. Upon your review, if you or your staff have any questions in regards to the application I am available at your convenience.

Sincerely,

ENVIRONMENTAL RESOURCES, INC.

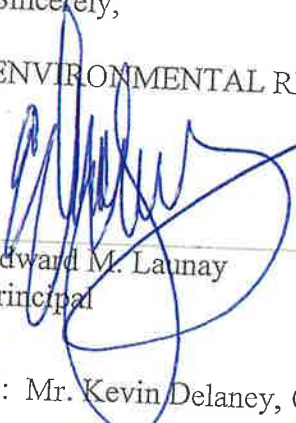
Edward M. Lannay
Principal

APR 10 2018

cc: Mr. Kevin Delaney, OHV DE., LLC.

DRAFT

Section 1: Applicant Identification

- Applicant's Name: OHV DE, LLC.
 Mailing Address: Attention: Mr. Keith Delaney
34 East Germantown Pike, #203
Norristown, PA 19401

Telephone #: 484-322-5440
 Fax #: _____
 E-mail: kdelaney@d2organization.com
- Consultant's Name: Edward M. Launay
 Mailing Address: 38173 DuPont Blvd
Selbyville, Delaware 19975

Company Name: Environmental Resources, Inc.
 Telephone #: (302) 436-9637
 Fax #: (302) 436-9639

E-mail: elaunay@ericonsultants.com
 Company Name: _____
 Telephone #: _____
 Fax #: _____
 E-mail: _____
- Contractor's Name: unknown
 Mailing Address: _____

E-mail: _____
 Company Name: _____
 Telephone #: _____
 Fax #: _____
 E-mail: _____

Section 2: Project Description

4. Check those that apply:
- New Project/addition to existing project? Repair/Replace existing structure? (If checked, must answer #16)

5. Project Purpose (attach additional sheets as necessary):
Improvements and redevelopment of former oyster house processing facility along Lewes Rehoboth Canal
to provide a community dock for up to 20 vessels for adjacent Oyster House Village residential community.
The dock will also be used by DNREC Waterway Management Program. (see attached)

6. Check each Appendix that is enclosed with this application:

<input checked="" type="checkbox"/> A. Boat Docking Facilities	<input checked="" type="checkbox"/> G. Bulkheads	<input checked="" type="checkbox"/> N. Preliminary Marina Checklist
<input checked="" type="checkbox"/> B. Boat Ramps	<input checked="" type="checkbox"/> H. Fill	<input checked="" type="checkbox"/> O. Marinas
<input checked="" type="checkbox"/> C. Road Crossings	<input checked="" type="checkbox"/> I. Rip-Rap Sills and Revetments	<input checked="" type="checkbox"/> P. Stormwater Management
<input checked="" type="checkbox"/> D. Channel Modifications/Dams	<input checked="" type="checkbox"/> J. Vegetative Stabilization	<input checked="" type="checkbox"/> Q. Ponds and Impoundments
<input checked="" type="checkbox"/> E. Utility Crossings	<input checked="" type="checkbox"/> K. Jetties, Groins, Breakwaters	<input checked="" type="checkbox"/> R. Maintenance Dredging
<input checked="" type="checkbox"/> F. Intake or Outfall Structures	<input checked="" type="checkbox"/> M. Activities in State Wetlands	<input checked="" type="checkbox"/> S. New Dredging

Section 3: Project Location

7. Project Site Address: 700' south of SR1
Highway bridge over Lewes Rehoboth Canal
- County: N.C. Kent Sussex
- Site owner name (if different from applicant): _____
- Address of site owner: United States of America
Attn: Nicole Desimond U.S. Army Corp of Engineers
Baltimore District Real Estate Division / PO Box 1715
Baltimore, Maryland 21203
8. Driving Directions:
From SR1 east of Route 1A Rehoboth Ave, access Oyster House Road; then proceed to Lewes-Rehoboth Canal on south
(Attach a vicinity map identifying road names and the project location) side of Oyster House Road.
9. Tax Parcel ID Number: 334-19.00-173.00 Subdivision Name: Oyster House Village

DRAFT

APR 10 2018

JK

WLS Use Only:

Permit #: 145/18

Type: SP SL SU WE WQ LA SA MP WA

Corps Permit: SPGP 18 20 Nationwide Permit #: _____ Individual Permit #: _____

Received Date: 4/24/18 Project Scientist: _____

Fee Received? Yes No Amt: \$ 2000 Receipt #: 783793

Public Notice #: _____ Public Notice Dates: ON _____ OFF _____

85 PN 783795
225th 783794

Section 2, Item 5 Project Description

The project site is Tax Map Parcel 334-19.00-173.00 located in the Lewes-Rehoboth Hundred, Sussex County, Delaware. The project involves redevelopment of 550 feet of shoreline on the western bank of the Lewes-Rehoboth Canal beginning 700 feet south of the Delaware State Route One highway bridge crossing the Canal. The project site is owned by the United States of America and managed by the U.S. Army Corps of Engineers (Corps) Real Estate Division. As is common practice along the Canal, the Real Estate Division grants a license for adjoining owners to obtain recreational water access.

The applicant OHV DE, LLC. is the owner and developer of Oyster House Village located on the abutting property, Tax Map Parcel 334-19.00-173.00. A residential community for 30 single family homes is approved at that location.

The proposed community dock and associated improvements as described below will provide Oyster House Village residents with recreational water access, including the ability to seasonally moor up to 20 vessels. Other benefits of the redevelopment project include remediation of severe bank erosion which is ongoing at the site, removal of deteriorated dock structures and piles which remain on the site from its past use as an oyster processing facility, and providing for an improved and expanded storage compound for the Delaware Department of Natural Resources and Environmental Control (DNREC) Waterway Management Section dredging operations.

The applicant will allow DNREC to seasonally use the northern portion of the community dock for the dredging operation which typically occurs through the fall and winter season. The elements of the proposed project are illustrated on plans entitled Proposed Community Dock at Oyster House Village, prepared by Solutions IPPEM, LLC. Georgetown, Delaware.

The elements of the proposed project are described as follows:

Community Dock: A 520 foot long, 6 foot wide community dock constructed parallel to the existing shoreline is proposed. The proposed dock and mooring area is located landward of the federal navigation channel and its 10 foot wide buffer. A maximum number of 20 boats will be seasonally moored along the proposed dock. The dock will be of typical marine construction using salt treated piles, timbers, and decking secured with galvanized hardware. Pile bent spacing will be 8 feet on center. Two six foot wide access piers totaling 17 feet channelward of mean high water will provide access between the dock and uplands. A kayak/canoe launch ladder will be located opposite the southern access pier. The elevation of the pier will be 3.5 feet (North American Vertical Datum) NAVD88. The local mean high water elevation is +1.2 feet NAVD88. The local mean low water elevation is -0.8 feet NAVD88.

APR 10 2018



DRAFT

An existing landing platform underlain by a timber crib structure back filled with earth occurs toward the northerly end of the proposed dock. This structure will be rebuilt and encased with 76 feet of vinyl sheet pile retaining wall constructed at or landward of the mean high water line. The proposed retaining wall will be even with the channelward face of the dock, thereby providing the main access point to it. As discussed later, this land access is important to patrons as well as to DNREC dredging crews who will use it for their seasonal operations. A hydrant for fire protection will be provided at this location as well.

Since the community dock is considered a marina under DNREC Regulations, other land based facilities are required. For fire protection, an additional hydrant will be located at the easterly access pier. A small marina storage building will be located at the northerly access pier. Marina signage, emergency spill kit, and a portable marine pump out station will be housed at the building.

Currently the DNREC Waterway Management Program has a lease for a storage compound enclosed with a chain link fence near the center of the site. As part of this project the storage compound will be enlarged and relocated to the north end of the site for improved access. Screened type fencing will be used for the enclosure. Gated access to the future vinyl sheet pile retaining wall landing will be provided. The applicant and DNREC have agreed that no mooring of resident's boats will be permitted on the north end of the pier after Labor Day and until April 15th of the calendar year. During this time DNREC will use the dock for mooring dredges and other vessels and the management and assembly of dredge spoil pipe.

Shoreline Stabilization: The entire shoreline opposite and extending beyond the proposed dock, 470 linear feet total will be stabilized with a riprap revetment constructed from quarry stone. Serious bank erosion is occurring through the central portion of the property where a high unstabilized vertical bank occurs. Existing concrete and rubble debris was used in the past to secure other portions of the shoreline. This material will be removed and replaced with a properly constructed riprap revetment underlain with geotextile fabric. Various riprap cross sections as illustrated by project plans will be used. In some areas, the bank will be pulled back to install the revetment.

A total of 30 square feet of waters channelward of mean low water will be filled by riprap. A total of 1800 square feet of intertidal area between mean low water and mean high water will be filled by riprap. A total of 60 cubic yards of quarry stone will be discharged below mean low water. Total volume of riprap is estimated at 340 cubic yards.

Maintenance Dredging: Minor maintenance dredging along the face of the proposed dock is required. Dredging depth will match the 3.5 foot depth NAVD88 of the canal. The navigation channel is currently approximately 6.0 feet below NAVD88. The proposed dredge depth will taper back to elevation 2.0 feet landward of the dock. Dredge material is dominated of sand sediments and cobble which was once used as backfill for crib and dock structures when the site was occupied by an oyster processing facility. Eroded bank material is another component. The total area of dredging is 7,275 square feet. The total volume of dredging is 300 cubic yards.

APR 10 2018

R

DRAFT

Disposal of spoil material will be on site within a low lying area at the south end of the project site. As shown on the site plan and Fill- Riprap Bank Section A, this portion of the site will be filled to elevations between 3.2 to 4.0 feet with spoils, compacted when dried and covered with a topsoil cap, seeded with grass for stabilization. During operations the fill area will be secured with super silt fence to prevent erosion. Use of mechanical dredging methods is proposed. The total area of the spoil disposal location is 15,200 square feet. Dredging operations will occur along with removal of existing docks and pilings and construction of riprap embankments. This work will be completed prior to the proposed community dock construction.

APR 10 2018

gk

DRAFT

Section 3: Project Location (Continued)

10. Name of waterbody at Project Location: Lewes Rehoboth Canal waterbody is a tributary to: Rehoboth Bay
 11. Is the waterbody: Tidal Non-tidal Waterbody width at mean low or ordinary high water 120 feet

12. Is the project: On public subaqueous lands? On private subaqueous lands?*
 In State-regulated wetlands? In Federally-regulated wetlands?

*If the project is on private subaqueous lands, provide the name of the subaqueous lands owner:

(Written permission from the private subaqueous lands owner must be included with this application)

13. Present Zoning: Agricultural Residential Commercial Industrial Other

Section 4: Miscellaneous

APR 10 2018

14. A. List the names and complete mailing addresses of the immediately adjoining property owners on all sides of the project (attach additional sheets as necessary):
The project site and its surroundings are located upon lands owned by the United States of America.
A lease will be granted by the Baltimore District Corps of Engineers Real Estate Section.
See list attached for adjoining owners.

B. For wetlands and marina projects, list the names and complete mailing addresses of property owners within a 1,000 foot radius of the project (attach additional sheets as necessary):

See Attached

15. Provide the names of DNREC and/or Army Corps of Engineers representatives whom you have discussed the project with:
Edward Bonner, ACOE Nicole Desimone, ACOE Scott Figurski, DNREC
Charles Myers, ACOE Chuck Williams, DNREC

A. Have you had a State Jurisdictional Determination performed on the property? Yes No
 B. Has the project been reviewed in a monthly Joint Permit Processing Meeting? Yes No
 *If yes, what was the date of the meeting? _____

16. Are there existing structures or fill at the project site in subaqueous lands? Yes No
 *If yes, provide the permit and/or lease number(s):
unknown - remains of oyster processing plant to be removed

*If no, were structures and/or fill in place prior to 1969? Yes No

17. Have you applied for or obtained a Federal permit from the Army Corps of Engineers?
 No Pending Issued Denied Date: February 28, 2018

APR 10 2018

Type of Permit: Individual DOA Permit Federal Permit or ID #: not assigned yet

JK

18. Have you applied for permits from other Sections within DNREC?
 No Pending Issued Denied Date: _____ Permit or ID #: _____

Type of permit (circle all that apply): Septic Well NPDES Storm Water

Other: _____

DRAFT

Section 5: Signature Page

19. Agent Authorization:

If you choose to complete this section, all future correspondence to the Department may be signed by the duly authorized agent. In addition, the agent will become the primary point of contact for all correspondence from the Department.

I do not wish to authorize an agent to act on my behalf

I wish to authorize an agent as indicated below

I, Keith Delaney, OHV DE, LLC., hereby designate and authorize Edward M. Launay, ERI
(Name of Applicant) (Name of Agent)
to act on my behalf in the processing of this application and to furnish any additional information requested by the Department.

Authorized Agent's Name: Edward M. Launay Telephone #: (302) 436-9637
Mailing Address: Environmental Resources, Inc. Fax #: (302) 436-9639
38173 DuPont Blvd. E-mail: elaunay@ericonsultants.com
Selbyville, Delaware 19975

20. Agent's Signature:

I hereby certify that the information on this form and on the attached plans are true and accurate to the best of my knowledge. I further understand that the Department may request information in addition to that set forth herein if deemed necessary to appropriately consider this application.

APR 10 2018

Agent's Signature

4/6/18
Date

21. Applicant's Signature:

I hereby certify that the information on this form and on the attached plans are true and accurate to the best of my knowledge and that I am required to inform the Department of any changes or updates to the information provided in this application. I further understand that the Department may request information in addition to that set forth herein if deemed necessary to appropriately consider this application. I grant permission to authorized Department representatives to enter upon the premises for inspection purposes during working hours.

Applicant's Signature

MARCH 26, 2018
Date

Print Name

KEITH J. DELANEY

22. Contractor's Signature:

I hereby certify that the information on this form and on the attached plans are true and accurate to the best of my knowledge, and that I am required to inform the Department of any changes or updates to the information provided in this application. I further understand that the Department may request information in addition to that set forth herein if deemed necessary to appropriately consider this application.

Contractor's Name

Date

Print Name

DRAFT

BOAT DOCKING FACILITIES

Any boat docking facility for more than four (4) vessels is considered a marina facility (see definitions and explanations section) and requires the applicant to complete Appendices N and O, and make application to the U. S. Army Corps of Engineers for approval.

Please make sure answers to all of the questions in this appendix correspond with information on the application drawings.

1. Briefly describe the project. (Attach additional sheets as necessary.)

Construction of a 520 foot long community dock, approximately 46 feet of which will be located over uplands. See Basic Application Section 2, Item 5.

2. Please provide numbers and dimensions as follows:

Structure Type	Number of Support Pilings	Dimensions (Channelward of MHW or OHW)		Dimensions (Channelward of MLW- n/a for non-tidal water)		New, repair or maintain
		Width ft.	Length ft.	Width ft.	Length ft.	
Dock, Pier, Lift, gangway						
dock	120	6	474	474	6	
north access pier	2	6	13	6	6	new
south access pier	0	6	4	6	3	new
kayak launch/ladder	0	6	3	0	0	new
Freestanding Pilings	Number 0					

Mooring Buoy: How many moorings will be installed? _____
 What will be used for the anchor(s)? _____
 Anchor/Mooring Block Weight _____
 Anchor Line Scope (Length or Ratio) _____
 Water Depth at Mooring Location _____

APR 10 2018

- Approximately how wide is the waterway at this project site? +/-108 ft. (measured from MLW to MLW)
 - What will be the mean low water depth at the most channelward end of the mooring facility? -3.0 ft. NAVD88
 - What type of material(s) will be used for construction of the mooring facility (e.g. salt treated wood, aluminum, fiberglass floats, etc.) Use of creosote-treated wood is prohibited.
 salt treated pilings & timber, galvanized hardware
 - Circle any of the following items that are proposed over subaqueous lands:
 Fish Cleaning Stations/Benches/Ladders/Water Lines/ Satellite/Electric Lines/ Handrails/Other (Describe)
 kayak launch / ladder
- If any of the items are circled above, include their dimensions and location on the application drawings.

7. What will be the distance from the most channelward end of the docking facility to the edge of any natural or man-made channel? 26 ft.

8. Describe the vessels that will be berthed at the docking facility. Please draw proposed vessel locations on plans and drawings.

Make/model <u>varies</u>	length _____	width _____	draft _____
Make/model _____	length _____	width _____	draft _____
Make/model _____	length _____	width _____	draft _____
Make/model _____	length _____	width _____	draft _____

9. Please provide a copy of the current state registration or Coast Guard Certificate of Documentation for each motorized vessel listed above. N/A

10. Give the number and type of each Marine Sanitation Device (e.g. MSD III, Portable toilet) that will be used on vessels to be docked at the facility. unknown, Marine pump out provided

11. Is there currently a residence on the property? _____ Yes X No

12. Do you plan to reach the boat docking facility from your own upland property? X Yes _____ No If "No", explain your proposed means of access and provide documentation of easement or documentation authorizing access if you intend to cross someone else's property. license to be issued by U.S. Army Corp of Engineers Real Estate Division

13. Will any portion of the structure be located in privately owned underwater land (such as a pond or lagoon) owned by someone other than the applicant? X Yes _____ No.
If yes, written permission of the underwater land owner must be provided with this application. license to be issued by U.S. Army Corp of Engineers Real Estate Division

14. What is the width of the waterfront property frontage adjacent to subaqueous lands? 520 ft.
Will any portion of the structure or any vessel be placed within 10 feet of your neighbor's property line? _____ Yes X No
If yes, a letter of no objection from the adjacent property owner must be included with this application.

APR 10 2018

Op

DRAFT

BULKHEADS

Please make sure answers to all of the questions in this appendix correspond to information on the application drawings.

1. Will the project be considered new construction or repair and replacement of an existing and currently serviceable bulkhead?

New Construction
 Repair and Replacement

If repair and replacement, attach photos of entire length of project.

1. What is the current condition of the shoreline at the site of the proposed bulkhead?
A bulkhead / retaining wall to be installed in uplands or on the channelward face of a former timber crib structure filled with rock (oyster house landing dock).

2. Please attach an analysis of all alternatives to bulkheading as a shoreline stabilization method for this project. Please examine options using vegetation and/or non-vertical walled structures. Include a justification of need, based on the extent of erosion and the rate of erosion. This application will not be reviewed if this answer is not completed. The proposed work will enclose the existing crib structure associated with landing. The area will be used as a landing and access for community dock structure.

3. If this is a repair or replacement,

Do you intend to step out in front of existing bulkhead? Yes No

Is the current bulkhead creosote? Yes No

Will the new bulkhead be placed on or off the applicant's property?
 On Off Please indicate property lines on attached plans as well as MHW/MLW.
ACOE Real Estate License

4. How many linear feet of shoreline are to be bulkheaded? 28 ft.

5. What will be the overall length of the bulkhead (including return walls)? 76 ft.

6. How many ends of the bulkhead will be tied into existing bulkheads which are in good repair?
 None One Two

7. Will the return walls be protected from out flanking with rip-rap?
 Yes No If your answer is "Yes", complete Appendix I.

8. Will the toe of your bulkhead be protected from undercutting with rip-rap?
 Yes No If your answer is "Yes" complete Appendix I.

9. What type of material(s) will be used for construction of the bulkhead (e.g. reinforced concrete, steel sheet pilings, treated tongue-and-groove timber, etc.)?
Vinyl sheet piling supported with salt treated pilings & walers

APR 10 2018

10. Will deadmen be utilized Yes No If your answer is "Yes", indicate the type and location on your drawings/ If your answer is "No", explain the method to be used to anchor the bulkhead.
11. Will wooden materials be: Salt Treated Other
12. Will all metal fittings, cables, or tie rods be galvanized? Yes No
13. Will the bulkhead be backfilled? Yes No If your answer is "Yes", complete Appendix H.
14. Will filter cloth be used? Yes No If your answer is "No", explain the method to be used to control seepage of backfill from behind the bulkhead.
15. Have you consulted an engineer or other professional to assure that the design of your bulkhead will be adequate? Yes No If your answer is "Yes", give the name and address of the party consulted.

Name: Solutions IPEM
Address: 303 North Bedford Street
Georgetown, DE

Date:

APR 10 2018



DRAFT

FILL

Please make sure answers to all of the questions in this appendix correspond to information on the application drawings.

1. How many linear feet will the fill extend channelward of the:
 - a. Tidal waters: mean high water line? varies ft. 0' to 5'
mean low water line? varies ft. 0' to 2'
 - b. Non-tidal waters: ordinary high water line? _____ ft.

2. What is the area of fill that will be located:
 - a. on subaqueous land (channelward of mean high water) 1830 sq. ft.
 - b. on vegetated wetlands? _____ sq. ft.

3. What is the source of the fill?

Hauled in from upland sources: What is the source company/location/parcel number?
 Obtained from dredged material: Complete Dredging Appendix.
 commercial quarry

4. What is the total volume of fill? 340 cubic yards
 - a. What is the total fill per running foot of shoreline? 0.7 cubic yards

5. What method will be used to place the fill?

rip rap placed by excavator working from uplands

6. State the type and composition percentage of the fill material (e.g. sand 80%, silt 5%, clay 15%, etc.)

100% quarry stone

7. How will the fill be retained? Complete appropriate appendix.

rip rap revetment only

8. What type of vegetation or ground cover will be provided for the filled area(s) to prevent soil erosion and help keep sediment from reaching State waters?

Not applicable

9. Describe the type(s) of structure(s) to be erected on the filled area (if any). Complete appropriate appendix.

None

Rip-Rap Sills and Revetments

Please respond to each question. Questions left blank may result in the application being returned as incomplete. In addition, the answers to all of the questions in this Appendix must correspond accurately to the information on the plan and section view drawings for the project.

1. Will the project be:

- New Construction (un-stabilized shoreline)
- Repair or Replacement of an Existing Rip-Rap Structure or Rubble
- Repair or Replacement of an Existing Bulkhead

(If repair or replacement, submit photographs of the entire existing structure).

2. How many linear feet of shoreline are proposed to be stabilized? 470

3. Is the project a: Standard rip-rap revetment Free-standing sill

4. Describe the existing shoreline:

Conditions along the shoreline vary. The southerly portion of the shoreline is defined by an old concrete foundation from the former oyster processing facility. The center is a high vertical bank with active serious erosion with no stablization. The north portion of the bank has stabilization with a mix of rip rap, concrete block, and brick. This would be cleaned up and reconstructed with clean quarry stone.

5. What is the total number of cubic yards of rip-rap that will be used? 340

6. What is the number of cubic yards of rip-rap per running foot of shoreline? 0.7

(See page 4 for a guide to calculating total cubic yards and cubic yards per running foot).

APR 10 2018

7. What will be the average weight of the stone used for the:

Armor stone: 30 lb. Core stone: 80 lb.

[If material other than stone, such as prefab geo-grid or other similar product is proposed, please describe here and include photographs or a brochure. The Department strongly discourages the use of broken concrete, cinderblocks or other materials that are less dense than stone, more apt to move off site due to currents or wave action, and/or are not aesthetically pleasing or in keeping with the natural environment.]

Describe:

standard quarry stone used

DRAFT

8. For Standard Revetments answer A-F, below: (for Sill projects, skip to Question #9)

A. How many linear feet will the structure extend channelward of:

Mean High Water: 0 to 5 Mean Low Water: 0 to 2

Ordinary High Water: _____ (for non-tidal waters)

B. How many square feet of the structure will be located:

Channelward of Mean High Water: 1800 Channelward of Mean Low Water: 30

Channelward of Ordinary High Water: _____ (for non-tidal waters)

On vegetated wetlands: _____

C. Will the revetment be backfilled? ___ Yes No no significant backfill proposed
If yes, complete Appendix H and include it in your application.

D. Will filter cloth be used behind the rip-rap structure? Yes ___ No

E. What is the average slope of the existing bank? 1:1 to vertical

F. What is the proposed slope of the rip-rap revetment? 1.5 to 1
(See page 3 for a guide to calculating slopes).

9. Sill Projects:

A. What is the base width of the proposed structure: _____

B. What is the top width of the proposed structure: _____

C. How many square feet of the structure will be located:

Channelward of Mean High Water: _____ Channelward of Mean Low Water: _____

Channelward of Ordinary High Water: _____ (for non-tidal waters)

On vegetated wetlands: _____

D. What will be the average height of the structure: _____

E. How much of the structure (in inches) will extend vertically above:

Mean High Water: _____ Ordinary High Water: _____ (for non-tidal waters)

APR 10 2018

F. Are breaks or notches proposed in the sill to allow for greater flushing? ___ Yes ___ No

G. Will fill material be placed behind the sill? ___ Yes ___ No If yes, complete appropriate appendix.

H. Will wetland vegetation be planted behind the sill? ___ Yes ___ No
If yes, complete Appendix H and include it in your application.

10. Construction Techniques (Complete for both Revetment and Sill Projects):

A. Will any dredging be required? ___ Yes No

If yes, please include appropriate dredging Appendix with your application).

B. Please describe the sequence of construction and any techniques that will be utilized to minimize adverse impacts on the aquatic environment, and to preserve existing vegetation (particularly woody vegetation) along the shoreline:

rip rap will be placed with an excavator working from uplands.

CALCULATIONS

RUN = Base width of the structure (in feet) RISE = Vertical height of the structure (in feet)

I. How to calculate total cubic yards:

$0.5 * RUN * RISE * \text{Linear feet of shoreline stabilized} / 27 = \text{Total Cubic Yards}$

II. How to calculate cubic yards per running foot of shoreline:

$\text{Total \# Cubic Yards} / \text{Linear feet of shoreline} = \text{Cubic yards per running foot}$

III. How to calculate slope: $\text{Slope} = \text{RUN} / \text{RISE}$

EXAMPLE:

If we propose to stabilize 100 linear feet of shoreline with a rip-rap revetment that has a basewidth of 6 feet and a height of 3 feet:

$0.5 * 6 * 3 * 100 / 27 = 33.33 \text{ Total Cubic Yards}$

II. $33.33 / 100 = 0.333 \text{ Cubic Yards per running foot}$

III. $6 / 3 = \text{Slope of } 2$

APR 10 2018

DRAFT

MAINTENANCE DREDGING OR EXCAVATING

- If dredged material is to be placed in a disposal site, a separate map showing the location of the disposal site should be attached. This drawing must indicate the proposed retention levees, weirs, spillways, and/or devices for retaining the materials.
On site area shown on plans
- Bottom samples to determine heavy metals or other toxic materials must be taken and analyzed if deemed necessary by the DNREC staff. The responsibility, as well as the expense incurred for obtaining and analyzing these samples, must be borne by the applicant.
No current or past industrial uses
- If maintenance dredging is to be done, evidence of previous dredging must be provided. Any previously issued permit with drawings which indicates the date the dredging occurred, the area involved and dredging depth constitutes acceptable proof.
Canal was created by Corps dredging
- Please make sure answers to all of the questions in this appendix correspond to information on the application drawings.

1. How many cubic yards of material will be MAINTENANCE DREDGED or excavated channelward of the:

- a. Tidal waters: mean high water line? 0 cu. yds.
mean low water line? 300 cu. yds.
- b. Non-tidal waters: ordinary high water line? N/A cu. yds.

Does this account for the total volume of proposed dredging for the project? X Yes No
If there is new dredging associated with this project (dredging beyond previously authorized dimensions) please fill out appendix S for new dredging.

2. What will be the dimensions of the dredged or excavated area relative to mean low water (for tidal areas only) or ordinary water level (for non-tidal areas only)?
560 length 0.8 depth +/-12 base width +/-13 top width 7,275 square feet
3. What are average existing depths in area of proposed dredging? -0.8 to -3.5 ft. (mlw/ohw)
Include a survey of proposed and existing depths on application drawings. see survey
4. What is the proposed dredging depth in relation to surrounding bathymetry? equal ft. (mlw/ohw)
Indicate both proposed depths and surrounding depths on attached drawings.
Dredging will be done to meet existing -3.50 foot depth
5. By what method(s) (hydraulic, clamshell or other) will the dredging be done? If other, explain:
mechanical excavation

DRAFT

APR 10 2018

gc

6. What is proximity of the dredging project to the nearest creek bank or banks? +/- 5 ft.

What are existing land uses along this bank(s)?

A bonded oyster processing facility

Describe the existing shoreline along this bank (vegetation, rip-rap, bulkhead, etc.).

Conditions vary from existing rip rap revetements to concrete bulkhead wall, timber crib structure at existing landing dock to eroding high upland banks

7. Describe characteristics of the material to be disposed including:
- Physical nature of material (i.e. sand, silt, clay, etc.). Give percentages of various fractions if available. 70% sand & cobble, 25% silt, 5% clay

- Chemical composition of material - Many areas have sediments with high concentration of pollutants (chemicals, organics etc.) which may be re-suspended or reintroduced into the water. For heavily industrialized sites, a chemical analysis of this material should be provided (if applicable). inorganic

- What are the dewatering properties of material to be disposal of?
good

8. How will the dredged or excavated material be transported to its disposal area?
offloaded from barge

9. Land Disposal Areas.

a. Describe dimensions, characteristics and exact locations of the proposed dredged material disposal site (provide photographs, directions to, and complete plans of disposal site).
rectangular low lying area 15,480 square feet on southerly portion of site.

b. Describe method of dredged material containment (embankment, behind bulkhead, etc.)

c. What type of leachates will be produced by the spoil material and what is planned for the protection of groundwater? none

d. Disposal site coordinates 38.705348 latitude 75.093530 longitude

e. What methods will be used to ensure that spoil water does not adversely affect water quality both during construction and after completion of the project?
spoils with silt fence area. any dewatering will be through sediment filter bag.

f. Describe present land use of the disposal site.
open field

APR 10 2018

10. Water Disposal Areas/ Beneficial Use Projects

Describe methods to be used for water disposal including volumes and site selection, and containment (if applicable). Include Fill or Wetland Appendix if applicable.

Not applicable

11. Describe the existing water characteristics at the site, including chemical analysis for water quality.

Tidal water of Lewes Rehoboth Canal

12. Identify the dredging and disposal schedule to ensure that operations do not degrade water quality during times of anadromous fish migration.

Dredging only September 15 through December 31 of any calander year

13. Has an Erosion and Sediment Control Plan been approved by the designated plan approval agency for the project? An Erosion and Sediment Control Plan is required for any project disturbing more than 5,000 square feet of uplands. Final approved plans must be received by this office prior to permit issuance.

Yes No Not required to be provided

Important time of year restriction information:

Please be advised that all dredging in the Inland Bays must be undertaken between September 1 and December 31 in order to protect summer and winter flounder and other aquatic species. Dredging in other Delaware waters may also be subject to certain time of year restrictions in order to protect fish and wildlife. Contact DNREC for more specific information regarding the restrictions that may apply within your project area.

APR 10 2018



DRAFT

PRELIMINARY MARINA SCREENING CHECKLIST

(To be submitted at least one week prior to the pre-application meeting)

* Provide the following information and/or answer the following with regard to the proposed marina project:

1. Applicant's (Property Owners) Name Telephone Number
 Address: OHV DE, LLC. Home (): _____
34 East Germantown Pike #203 Work (): 484-322-3440
Norristown, PA 19104

Project Name: Oyster House Village Community Dock

2. Provide an aerial photograph of the site, if available.
3. What are the existing land uses on the site?
 Residential use surrounds, site is a former oyster processing facility
4. What are the existing land uses on adjacent properties within 1000 feet of the proposed marina or marina alteration, including the opposite shore?
 residential & municipal wastewater facility
5. Name and distance of nearest municipality.
 Rehoboth Beach
6. Is the proposed project an open water or enclosed basin marina?
 Open water Enclosed basin
7. Is the marina on a creek, river, or open bay? Name of the water body?
 Lewes Rehoboth Canal
8. Indicate the number of wet slips. Proposed 20 Existing _____
9. Indicate the number of dry stack spaces. Proposed 0 Existing 0
10. Will the proposed marina or marina alteration require dredging?
 Yes No
 If yes, approximate the amount in cubic yards. 300 cubic yards
11. If the project requires dredging, do you own or have access to an upland site for dredged material disposal? _____
 Yes No If yes, where is it located? on-site
12. If not, how do you propose to dispose of your dredged material? mechanical dredging
13. How many years of maintenance dredge spoil capacity does the spoil site possess?
0 Years

APR 10 2018

g

DRAFT

14. Will the proposed project require the use of any State wetlands? ___ Yes No If yes, approximate the amount of wetlands required in acres and the intended use.

15. What is the tide range at the marina site? Normal tide 2.0 Neap tide 1.6
 What is the source of this information?

16. What is the approximate MLW depth at the marina site? 2.5 Ft.
 What is the source of this information? Not applicable

17. If the site includes residential development, indicate:

Number of units platted 30

Length of shoreline owned N/A

Acreage of upland property 4.5 AC

Indicate the number of on-site parking spaces for:

	cars	trailers	cars with trailers	oversize vehicles
Proposed	0	0	0	0
Existing	0	0	0	0

18. What utilities will be provided on or in the marina or dock area proper? Be specific, e.g. fuel, electricity, sewage pump-out, water, etc. water to hydrants located near dock. Electric to pier.

19. What additional shore-based facilities are included in the proposed marina or marina alteration? Be specific, e.g., boat or engine repairs, fuel, foods, etc. small building for portable marine pump out station and emergency spill kit

20. Will the marina project be available to the general public? If so, on what basis?
 No

21. Are existing public facilities, services, and transportation adequate to accommodate the project and associated development impacts? Yes ___ No If no, please describe the upgrades required:

22. Has a market study been completed for the project? ___ Yes No
 If so, please attach the study report.

23. If no market study has been completed, please describe briefly the intended market, particularly the types and sizes of boats anticipated to use the facility.

Intended market is 30 families who will reside in Oyster House Village

APR 10 2018



DRAFT

MARINAS

Marina applicants must complete this appendix and any other appendices that may apply to the proposed project (see "List of Appendices").

Please be sure that answers to all of the questions in this appendix correspond to information on the application drawings.

1. Name of marina: Oyster House Village Community Dock

2. Complete mailing address for marina: unknown

Telephone Number: unknown

3. Name and complete address for Harbormaster, if applicable:

Mr. Keith Delaney
OHV DE, LLC.
34 East Germantown Pike, #203
Norristown, PA 19401

4. Check appropriate box: New Marina Alteration to Existing Marina

5. Number of Slips: Complete Appendix A for details of docking facilities.

a. Wet Slips Dry Storage Spaces
b. Existing 1
c. Proposed or Additional 20 maximum

APR 10 2018

g

• If this is an alteration to an existing marina, please be advised that the questions that follow pertain only to the altered portion(s) of the facility.

6. Shellfish Resources: Is any part of the marina located within or adjacent to a classified shellfish growing area? This information can be obtained from the Division of Watershed Stewardship, Watershed Assessment Section (302-739-9939)

 Yes No

If yes, how is the area currently classified?

 Approved Area Conditionally Restricted Area
 Conditionally Approved Area Prohibited Area
 Restricted Area

DRAFT

7. Submerged Aquatic Vegetation (SAV): Are any SAV beds located within the marina basin or adjacent areas? Yes No

8. Critical Habitats: Is the marina located within or adjacent to an area classified as a critical habitat by the Department's Division of Parks and Recreation? Critical habitat areas are those that are included in the Natural Areas Inventory, or that provide habitat for species included in the State Endangered Species Act (7 Del. C., Chapter 6). To obtain the locations of these areas, contact the Division of Parks and Recreation at (302) 739-5285. Yes No

9. Dredging and Dredged material Disposal: Complete Appendices R and/or S.
 provided

10. Shoreline Protection Structures: Complete appropriate Appendices.
 provided

11. Water Supply: Describe the existing or proposed water supply facilities for the project.

Public water system. Identify: City of Rehoboth

Private well. If existing, include the DNREC Well Permit Number: _____

If there are plans to construct a new well, a permit must be obtained from the Department's Water Supply Section prior to well construction.

12. Wastewater Facilities:

a. How many restroom facilities are planned for the marina? None

If none, please explain: Patrons will use residence or Oyster House Village Clubhouse

b. How will the wastewater from the facility be handled?

Public sewer, identify: Sussex County

On-site septic system

Other, describe:

c. Identify the permit numbers for any treatment, storage or disposal permits that have been obtained for the proposed wastewater facilities, including name and permit number for any waste transporters who will be transporting wastewater or septage.

not applicable

d. If permits for the wastewater facilities have not yet been obtained, have permit applications been submitted? Yes No

If Yes, show the date and to whom the application was mailed. If no, describe all proposed plans for wastewater handling. Attach additional sheets as necessary. Not applicable

13. Parking:

How many parking spaces will be provided? None

Does the proposed parking plan conform to: Patrons will be parked at Oyster House Village Local planning codes or requirements; (Contact the County Planning Department and/or local municipal government offices for this information).

The 0.5 spaces/slip rebuttable presumption from the Marina Regulations Yes No

If no, please explain: Patrons will be parked at Oyster House Village

APR 10 2018



DRAFT

14. Stormwater Management: Describe in detail the plans to detain the first one-half inch of stormwater run-off from the disturbed portion of the site and release it over a 24 hour period. Attach additional sheets and drawings as necessary.

No paving is proposed as part of community pier. Oyster House Village will be built in accordance with Soil Erosion and Stormwater plans approved by Sussex Conservation District

15. Solid Waste Management:

How many trash receptacles/ recycling bins will be provided at the marina? None

If trash receptacles will not be provided, what measures will be taken to ensure that solid wastes are properly disposed of? Patrons will be living in the adjacent community where waste disposal will be provided.

16. Boat Maintenance Areas and Activities:

a. Describe in detail how boat maintenance by-products, debris, residues, spills and run-off from maintenance areas will be controlled in accordance with the Marina Regulations. Attach separate sheets if necessary. No maintenance will be permitted. Docking only

b. Will special containers for waste oils and other maintenance wastes be provided? Yes
 No Explain: No maintenance will be permitted. Residents will use their own trash pick up.

c. Describe in detail how materials used in maintenance and repair operations will be handled and stored. Materials of concern include, but are not limited to, paints, solvents, oils, greases, preservatives, pesticides, epoxies and corrosive cleaners. Indicate whether local fire codes or national Fire Protection Association (NFPA) standards have been used in developing the proposed handling and storage. Attach separate sheets if necessary.
 No repairs or maintenance will be conducted at the community dock. Dock will have hydrants adjacent to dock at two locations for fire protection.

17. Fuel Storage and Delivery Facilities/Spill Contingency Plan:

APR 10 2018

a. Describe in detail all procedures for storage, handling and dispensing of fuel. Indicate whether local fire codes or National Fire Protection Association (NFPA) standards have been used in developing proposed procedures. A permit from the Department's Underground Storage Tank Branch may also be required. Attach separate sheets as necessary.

no fuel service

b. Describe in detail procedures that will be used to contain and clean any fuel spills that occur as a result of marina operations. Notification procedures should also be described. Attach separate sheets if necessary.

A spill kit will be kept at the community dock (See O&M Plan)

DRAFT

18. Fire Protection Systems: Describe the fire protection systems that are proposed for the facility. Indicate whether local fire codes or National Fire Protection Association (NFPA) standards have been used in choosing and designing the systems. Attach additional sheets as necessary.

Hydrants will be located adjacent to dock at two locations.

19. Life Safety Equipment:

- a. For alterations to existing marinas: Does the alteration involve the addition of new water-based structures? Yes No If yes, complete 20 B. If no, skip to question 21.
- b. How many floatation devices will be provided around the marina and how far apart will they be located? Two, one at each access pier to dock

20. Fish Waste:

Will fish cleaning stations be provided? Yes No

If yes, how many? _____ (Be sure to show their location on the engineering plans).

Will the marina provide a live bait concession? Yes No

21. Piers and Docks: Complete Appendix A.

22. **Drawing Requirements:** At a minimum, all marina applicants must submit at least the following drawings:

- a. Elevation or Section View
- b. Vicinity Map
- c. Plan View

- General Information for All Drawings: For all major structures, the structural dimensions and distance from the nearest property line, survey marker or permanent landmark should be shown.
- Wherever possible, identify the materials used in construction. If dredging or filling is involved, show the volume and type of materials to be moved, and the grade to be used.

- a. Elevation or Section View

The elevation or section view includes the following, as applicable: (check those which apply). Pre-checked items must be included.

- Mean high and low water lines;
- Construction details for all water-based structures (e.g. piers docks, pilings);
- Construction details for all bulkheads, rip-rap and other shoreline protection structures;
- Intake and outfall structures
- Boat Ramps
- Channel or basin modifications (proposed dredging areas)
- Other

- b. Vicinity Map

APR 10 2018

[Handwritten Signature]

DRAFT

c. Plan View

The plan view should be prepared on 8 1/2" x 11" paper, and in a standard blue print size and format, and contain the locations of the following features, as applicable (Check all those which apply to the project and include these items on the plan view drawing):

Provided - See project plans

- Property boundaries
- Shoreline
- Mean high and low water lines
- Direction of river flow/ebb and flow of tide
- Proposed channel
- Navigation Aids
- Piers, docks, pilings, bulkheads, moorings, anchorages, jetties, groins, breakwaters and other water-based structures
- Slips (Wet)
- Slips (Dry)
- Boat ramp(s)
- Buildings, other structures (identify each)
- Boat storage areas/facilities
- Boat maintenance area(s)
- Extent of roof coverage (e.g. over maintenance areas, boat storage areas, etc.)
- Roadways (identify surface, e.g. asphalt, gravel dirt, etc.)
- Parking areas (identify surface, e.g. asphalt, gravel, dirt, grass, etc.)
- Maintenance materials storage areas(s)
- Public telephone(s)
- Public restroom(s)
- Fish cleaning station(s)
- Life safety equipment station(s)
- Fuel dispensing pump(s) underground storage tank
- Septic tank
- Sewer connection/wastewater collection system
- Water supply well
- Portable fire extinguisher(s), fire hydrant(s)
- Spill containment equipment storage areas(s)
- Trash receptacle(s) waste oil - other waste receptacles
- Stormwater management facilities
- Compensation area for wetlands
- Other

APR 10 2018

gc

DRAFT

**SITING AND DESIGN STUDY
FOR
OYSTER HOUSE VILLAGE COMMUNITY DOCK**

Tax Map No.: 334-19.00, Parcel: 173.00

Lewes – Rehoboth Canal, Sussex County, Delaware

August 17, 2018

Prepared for:

OHV DE. LLC.
34 East Germantown Pike, #203
Norristown, PA 19401

Prepared By:

ENVIRONMENTAL RESOURCES, INC.

38173 DuPont Blvd.
P.O. Box 169
Selbyville, DE 19975
Phone: 302-436-9637



ERI Project No.: 0807#0696

**SITING AND DESIGN STUDY
FOR
OYSTER HOUSE VILLAGE COMMUNITY DOCK**

SUSSEX COUNTY, DELAWARE

Table of Contents:

Project Description.....1

Environmental Setting.....3

Water Quality Conditions.....4

Siting and Design Study Conclusions.....5

List of Exhibits:

- Exhibit 1:** Historic Water Quality Conditions – DEMAC Water Quality Portal Station 30511 Lewes-Rehoboth Canal @ Rt. 1
- Exhibit 2:** Permit Drawings, “Proposed Oyster House Village Community Dock , prepared by Solutions Integrated Planning, Engineering, and Management, LLC, Sheets 1 through 8, dated: 2/14/2018
- Exhibit 3:** USFWS – Threatened & Endangered Species List

List of Figures:

- Figure 1:** USGS Topographic Map
- Figure 2:** Vicinity Map
- Figure 3:** Resource Guidance Map
- Figure 4:** 11”x17” Existing Conditions Map

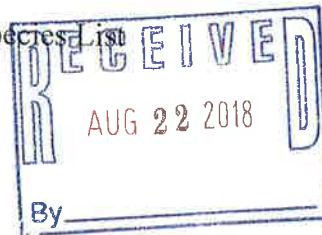

PROJECT DESCRIPTION & LOCATION

The project site is Tax Map Parcel 334-19.00-173.00 located in the Lewes-Rehoboth Hundred, Sussex County, Delaware. The project involves redevelopment of 550 feet of shoreline on the western bank of the Lewes-Rehoboth Canal beginning 700 feet south of the Delaware State Route One highway bridge crossing the Canal. The project site is owned by the United States of America and managed by the U.S. Army Corps of Engineers (Corps) Real Estate Division. As is common practice along the Canal, the Real Estate Division grants a license for adjoining owners to obtain recreational water access.

The applicant OHV DE, LLC. is currently the equitable owner and developer of Oyster House Village located on the abutting property, Tax Map Parcel 334-19.00-173.00. A residential community for 30 single family homes is approved by Sussex County at that location.

The proposed community dock and associated improvements as described below will provide Oyster House Village residents with recreational water access, including the ability to seasonally moor up to 20 vessels. Other benefits of the redevelopment project include remediation of severe shoreline bank erosion which is ongoing at the site, removal of deteriorated dock structures and piles which remain on the site from its past use as an oyster processing facility and providing for an improved and expanded storage compound for the Delaware Department of Natural Resources and Environmental Control (DNREC) Waterway Management Section dredging operations.

The applicant will allow DNREC to seasonally use the northern portion of the community dock for the dredging operation which typically occurs through the fall and winter season. The elements of the proposed project are illustrated on plans entitled Proposed Community Dock at Oyster House Village, prepared by Solutions IPEM, LLC. Georgetown, Delaware.

The elements of the proposed project are described as follows:

Community Dock: A 520-foot-long, 6-foot-wide community dock constructed parallel to the existing shoreline is proposed. The proposed dock and mooring area are located landward of the federal navigation channel and its 10-foot-wide buffer. A maximum number of 20 boats will be seasonally moored along the proposed dock. The dock will be of typical marine construction using salt treated piles, timbers, and decking secured with galvanized hardware. Pile bent spacing will be 8 feet on center. Two six-foot-wide access piers totaling 17 feet channelward of mean high water will provide access between the dock and uplands. A kayak/canoe launch ladder will be located opposite the southern access pier. The elevation of the pier will be 3.5 feet (North American Vertical Datum) NAVD88. The local mean high water elevation is +1.2 feet NAVD88. The local mean low water elevation is -0.8 feet NAVD88.

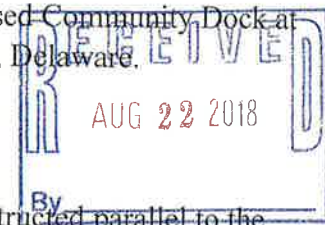

An existing landing platform underlain by a timber crib structure backfilled with earth occurs toward the northerly end of the proposed dock. This structure will be rebuilt and encased with 76 feet of vinyl sheet pile retaining wall constructed at or landward of the mean high water line. The proposed retaining wall will be even with the channelward face of the dock, thereby providing the main access point to it. As discussed later, this land access is important to patrons as well as to DNREC dredging crews who will use it for their seasonal operations. A hydrant for fire protection will be provided at this location as well.

Since the community dock is considered a marina under DNREC Regulations, other land based facilities are required. For fire protection, an additional hydrant will be located at the easterly access pier. A small marina storage building will be located at the northerly access pier. Marina signage, emergency spill kit, and a portable marine pump out station will be housed at the building.

Currently the DNREC Waterway Management Program has a lease for a storage compound enclosed with a chain link fence near the center of the site. As part of this project the storage compound will be enlarged and relocated to the north end of the site for improved access. Screened type fencing will be used for the enclosure. Gated access to the future vinyl sheet pile retaining wall landing will be provided. The applicant and DNREC have agreed that no mooring of resident's boats will be permitted on the north end of the pier after Labor Day and until April 15th of the calendar year. During this time DNREC will use the dock for mooring dredges and other vessels and the management and assembly of dredge spoil pipe.

Shoreline Stabilization: The entire shoreline opposite and extending beyond the proposed dock, 470 linear feet total will be stabilized with a riprap revetment constructed from quarry stone. Serious bank erosion is occurring through the central portion of the property where a high unstabilized vertical bank occurs. Existing concrete and rubble debris was used in the past to secure other portions of the shoreline. This material will be removed and replaced with a properly constructed riprap revetment underlain with geotextile fabric. Various riprap cross sections as illustrated by project plans will be used. In some areas, the bank will be pulled back to install the revetment.

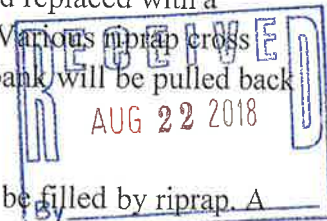

A total of 30 square feet of waters channelward of mean low water will be filled by riprap. A total of 1800 square feet of intertidal area between mean low water and mean high water will be filled by riprap. A total of 60 cubic yards of quarry stone will be discharged below mean low water. Total volume of riprap is estimated at 340 cubic yards.

Maintenance Dredging: Minor maintenance dredging along the face of the proposed dock is required. Dredging depth will match the 3.5 foot depth NAVD88 of the canal. The navigation channel is currently approximately 6.0 feet below NAVD88. The proposed dredge depth will taper back to elevation 2.0 feet landward of the dock. Dredge material is dominated of sand sediments and cobble which was once used as backfill for crib and dock structures when the site

was occupied by an oyster processing facility. Eroded bank material is another component. The total area of dredging is 7,275 square feet. The total volume of dredging is 300 cubic yards.

Disposal of spoil material will be on site within a low lying area at the south end of the project site. As shown on the site plan and fill-riprap bank section A, this portion of the site will be filled to elevations between 3.2 to 4.0 feet with spoils, compacted when dried and covered with a topsoil cap, seeded with grass for stabilization. During operations the fill area will be secured with super silt fence to prevent erosion. Use of mechanical dredging methods is proposed. The total area of the spoil disposal location is 15,200 square feet. Dredging operations will occur along with removal of existing docks and pilings and construction of riprap embankments. This work will be completed prior to the proposed community dock construction.

ENVIRONMENTAL SETTING

Construction of the Lewes-Rehoboth Canal was completed by the Corps of Engineers in 1977. The canal is part of the federally maintained intercoastal waterway system.

The Lewes-Rehoboth Canal watershed is made up of 45,000 acres in eastern Sussex County. It is a sub watershed of the Rehoboth Bay. The canal is approximately 10 miles long connecting the Delaware Bay to the Rehoboth Bay. Net tidal flow is believed to be directed toward the Rehoboth Bay. The proposed community dock will be located approximately 1.15 miles north of the canal entrance onto Rehoboth Bay. The normal tidal range at the site is 2.0 feet. Mean high water is +1.2 feet and mean low water is -0.8 feet on the NAVD 88 datum.

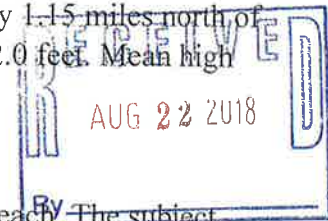

The project area is a largely developed and urbanized suburb of Rehoboth Beach. The subject site is surrounded by existing residential uses. The project site is the former location of a shellfish processing facility. Remains of the facility including concrete bulkheads, a crib landing structure and remains of timber bulkheads and mooring pilings are found along the entire shoreline. Since the site is highly disturbed due to filling as a result of initial construction of the canal and past uses, no historic or cultural resourced exist on the community dock site.

Existing conditions at the project site are shown on the enclosed plan entitled "*Boundaries of Waters of the United States including Wetlands Subject to the Corps of Engineers Regulatory Program, Lands of the United States of America, Lewes-Rehoboth Canal*" prepared by Solutions IPEM, Georgetown, DE. This plan is provided as Figure 4 of this report.

No state regulated wetlands are mapped on the project site. A narrow fringe of emergent wetlands exists along the shoreline opposite this project. A significant portion of the sites shoreline is a tall vertical unstabilized bank undergoing significant erosion. Other portions of the shoreline have been stabilized with a mixture of riprap, brick, concrete rubble and other debris as part of past uses of the site.

The Lewes-Rehoboth Canal is 5.0 to 6.0 feet deep (NAVD88) within the maintained 55-foot-wide federal navigation channel. A 10-foot-wide buffer area exists on both sides of the federal channel. No portion of the proposed community dock or boat mooring area will encroach into the 10-foot-wide federal channel or buffer. From that point the sides of the channel shallow up to mean low water elevation along the toe of the shoreline. At mean low water the canal is approximately 108 feet wide. Adequate water depths for a community dock are present. Only minor maintenance along the dock edge of material recently eroded from shoreline banks is needed to develop the dock. Sediments are relatively sandy.

Onsite soils as mapped by the USDA Soil Survey for Sussex County consist of the Brockatonorton Urban land complex. This well drained series has generally sandy textures consistent with prior urban uses and past filling activities.

No submerged aquatic vegetation is present in the vicinity of the project. Shell fishing is prohibited within the Lewes-Rehoboth Canal and shellfish resources are not known to be prevalent in the project area. In accordance with the U.S. Fish & Wildlife Service records no threatened or endangered species or their critical habitats are present.

WATER QUALITY CONDITIONS

A summary of historic water quality data representative of conditions for the Lewes-Rehoboth Bay was obtained from the Delaware Environmental Monitoring and Analysis Center (DEMAC) Water Quality Portal is provided in **Exhibit 1** of this study. The mooring station (Station 305011) is located at the State Route 1 Bridge crossing the canal. This location is only 700 feet north of the project site.

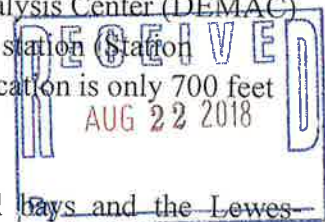

Dissolved oxygen (DO) concentrations in Delaware's shallow inland bays and the Lewes-Rehoboth Canal have dissolved oxygen levels that naturally cycle over 24 hours. During the day, plants and algae release oxygen into the water through photosynthesis. At night, plants, algae, and animals continue to respire and draw oxygen out of the water. Nutrient pollution can make these cycles extreme by fueling algal blooms. When the excessive algae respire at night, they can cause oxygen to drop below healthy levels. A healthy standard for DO levels in the inland bays is generally considered to be a DO of 4.0 mg/l.

Data collected in the canal between 2000 and 2016 showed a low average DO concentration of 4.41 mg/l in July and a peak concentration of 10.67 mg/l in January. Therefore, DO concentrations at the project site exceed the standards for healthy DO concentrations in the inland bays.

Due to the greater tidal amplitude and currents within the setting of the canal dissolved oxygen can be expected to be greater than that of the inland bays due to better flushing. Elimination of the Rehoboth Beach sanitary sewer outfall into the canal can also be expected to improve future water quality. Other parameters such as Water Temperature, pH, Total Nitrogen, Total Phosphorous, Enterococcus, Salinity, Total Suspended Solids, Chlorophyll A are also reported at this station.

SITING AND DESIGN STUDY CONCLUSIONS

The design of The Oyster House Village Community Dock facility meets all regulatory requirements and design standards of DNREC's Marina and Subaqueous Lands Regulations. It is a minor marina facility. The capacity of the community dock is capped at no more than 20 small recreation crafts. The proposed location is favorable as it is redevelopment of a previously existing waterfront shellfish processing facility and developed shoreline. Project impacts are thereby minimized, and no wetland impacts will result from the project. Adequate water depths exist without the need for substantial dredging even on a long-term basis. The project does not adversely impact boat navigation or the navigable federal channel. This small community dock does not impact any nearby piers or other development; therefore, the facility has no impacts on neighboring properties.

No shellfish resources or submerged aquatic vegetation exist at the community dock location. The community dock lies within waters prohibited for shellfishing. Water quality conditions at the community dock are favorable and the dock will not result in a violation of state water quality standards. The marina will operate under an approved Operation and Maintenance Plan (O&M Plan). A marina pump out station will be provided. The residential development site is serviced by public water and sanitary sewer. Fish cleaning at the facility is prohibited by the O&M Plan. Lastly, endangered species or historic and cultural resources will not be impacted. Based on this summary of conclusions, the development of the proposed community dock is not adverse to public interest.



EXHIBIT 1

Historic Water Quality Conditions
DEMAC Water Quality Portal
Station 30511
Lewes-Rehoboth Canal @ Rt. 1



Historical Data for 305011



Station Name: Lewes & Rehoboth Canal @ Rt. 1
Period of Record: Mar 09, 2000 - Aug 23, 2017
Classification: Salt Water
Basin: Inland Bays [↗](#)
Watershed: Lewes-Rehoboth Canal [↗](#)
[Download Historical Station Data \(.csv\)](#)



Water Temperature

Temperature, like salinity, undergoes wide variations seasonally, although it is much less variable and much more predictable than any other water quality parameter displayed here. This can be seen by looking at the historical range for the long-term stations for any given month. This relative stability is due to the heat retaining properties of water, which make it much more resistant to temperature changes than our atmosphere.

Water Temperature

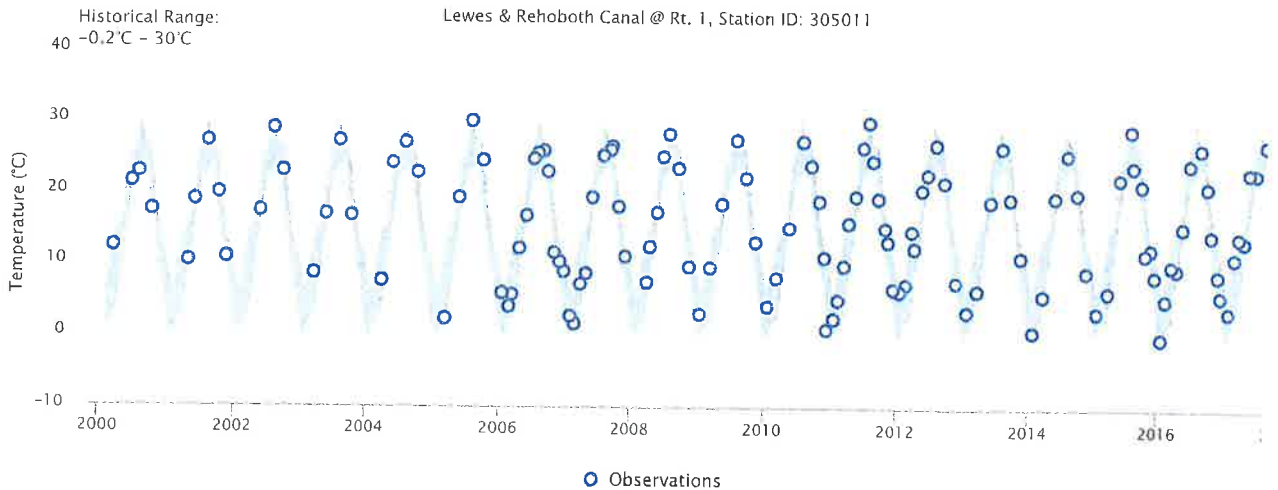

DNREC Surface Water Quality Monitoring Program

Hide Historical Data Range



	Jan	Feb	Mar	Apr	May	Jun	Jul	Aug	Sep	Oct	Nov	Dec
Min	-0.2	1.5	2.3	8.6	15.1	21.3	22.7	23.9	17.4	11.5	7.5	0.9
Avg	3.5	10.2	12.1	13.2	22	23.2	27.2	26.9	21.4	14.5	9.2	6
Max	6.2	11.2	14.7	15.8	24	26.5	30	27.1	26.5	18.9	13.2	11

pH

pH, in simple terms, is a chemical measure of whether or not something is an acid or a base. It is measured on a log scale of 0 to 14, with each unit representing a ten-fold change. A pH of 7.0 is considered neutral and a range of 5.5 to 8.5 is usually tolerated by most aquatic organisms. Lower pHs are sometimes seen in fresher waters due to acid

precipitation or even naturally-occurring organic acids, which can be found in areas with extensive marshes. High pHs can occur during algae blooms due to chemical reactions associated with photosynthesis.

Moderate to higher salinities usually "buffer" in the 7 to 8 range, so most of the more extreme values are generally found in low salinity waters.

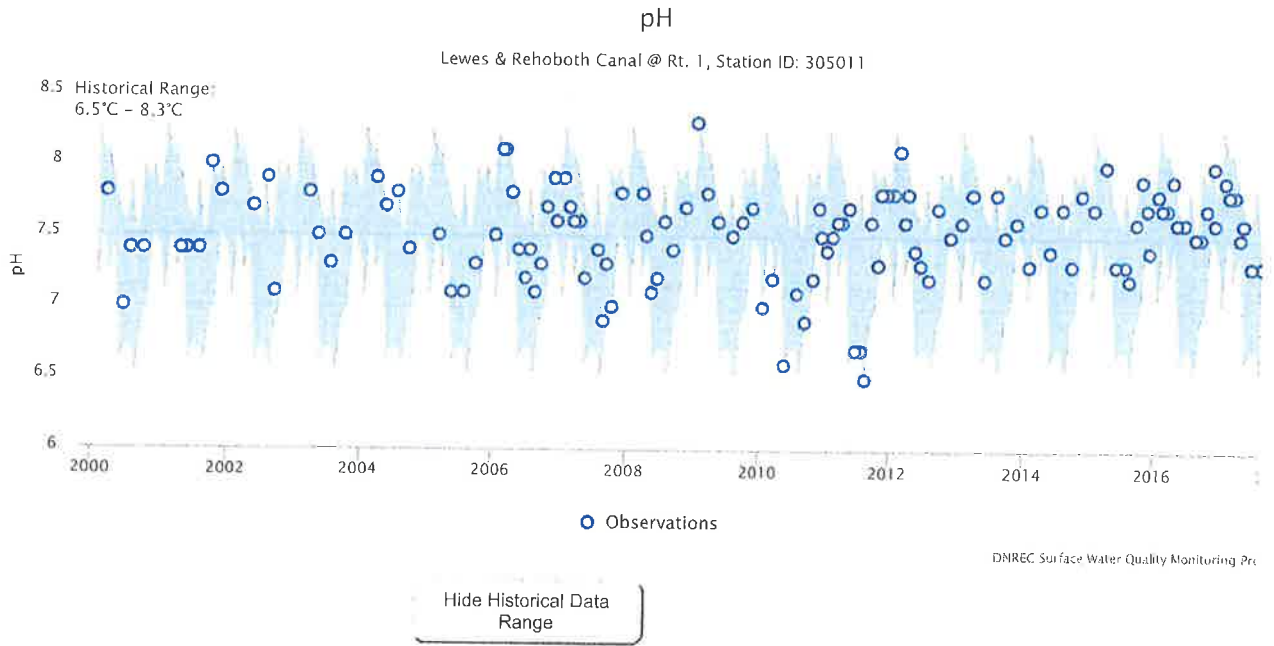

	Jan	Feb	Mar	Apr	May	Jun	Jul	Aug	Sep	Oct	Nov	Dec
Min	7	7.5	7.2	7.4	6.6	6.7	6.7	6.5	6.9	7	7.5	7.4
Avg	7.8	7.8	7.8	7.5	7.5	7.3	7.4	7.3	7.5	7.6	7.9	7.6
Max	8.3	8.1	8.1	7.9	7.7	7.6	7.9	7.5	8	7.9	8	7.8

Dissolved Oxygen (DO)

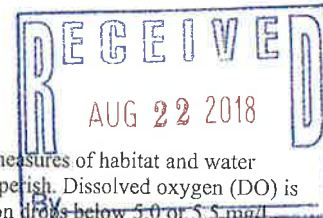

The amount of oxygen dissolved in surface waters is one of the most important measures of habitat and water quality. This is because without oxygen, all of the living resources familiar to us perish. Dissolved oxygen (DO) is measured as a concentration (mg/l ~ milligrams per liter). When DO concentration falls below 5.0 or 5.5 mg/l, many sensitive organisms such as fish, become stressed, especially if exposed to these low DO conditions for a long period of time. On the other hand, bottom-dwelling organisms such as worms are usually more tolerant, and some species can survive at levels down to 1 mg/l in some cases.

The concentration of DO is affected by several factors. Temperature affects the concentration since warmer water cannot dissolve as much oxygen as colder water. In addition to temperature, the amount of algae in the water can also impact DO levels. Supersaturation (over 100% DO saturation) can occur when there is a large algal bloom. During the daylight, when the algae are photosynthesizing, they can produce oxygen so rapidly that it is not able to escape into the atmosphere, thus leading to short-term saturation levels of greater than 100%. In most cases, the DO graphs from the continuous monitoring stations show daily variations, with peaks in late afternoon and minimums at dawn. These peaks are due to the production of oxygen by algae (measured by chlorophyll) during the daytime and the consumption of oxygen at night by algae and other organisms in the water and bottom sediments. These daily swings can be quite large when there are algae blooms fueled by nutrient pollution, and they often result in fish kills when oxygen levels drop to around 1 mg/l or less.

Dissolved Oxygen (DO)

Lewes & Rehoboth Canal @ Rt. 1, Station ID: 305011

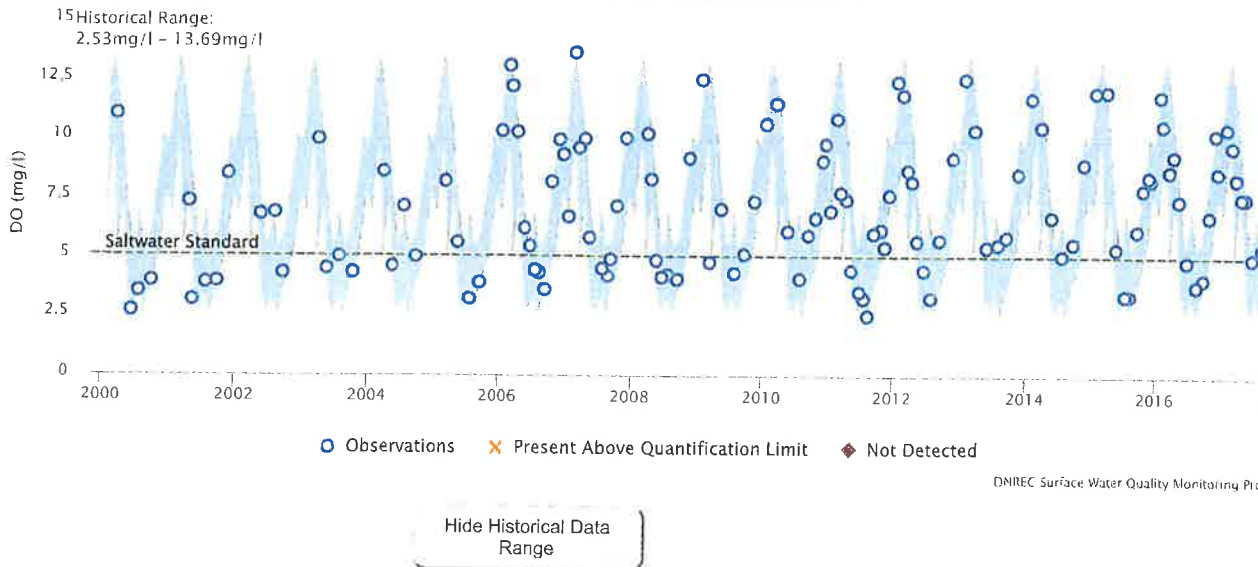

	Jan	Feb	Mar	Apr	May	Jun	Jul	Aug	Sep	Oct	Nov	Dec
Min	6.7	5.3	4.78	5.5	3.15	2.69	3.19	2.53	3.34	4.3	5.44	7.64
Avg	10.67	10.03	8.98	7.8	6.53	4.81	4.41	4.96	4.47	6.78	9.6	8.76
Max	12.9	13.69	12.25	10.28	7.72	5.7	7.13	5.43	6.4	8.5	10.4	10.7

Total Nitrogen (N)

Nitrogen is a nutrient and is essential element for both plants and animals. However, presence of excessive amounts of nitrogen in surface waters causes undesirable conditions leading to nutrient overenrichment. Symptoms of nutrient overenrichment include excessive algal blooms, large daily swings in dissolved oxygen levels, loss of Submerged Aquatic Vegetation (SAV), and fish kills.

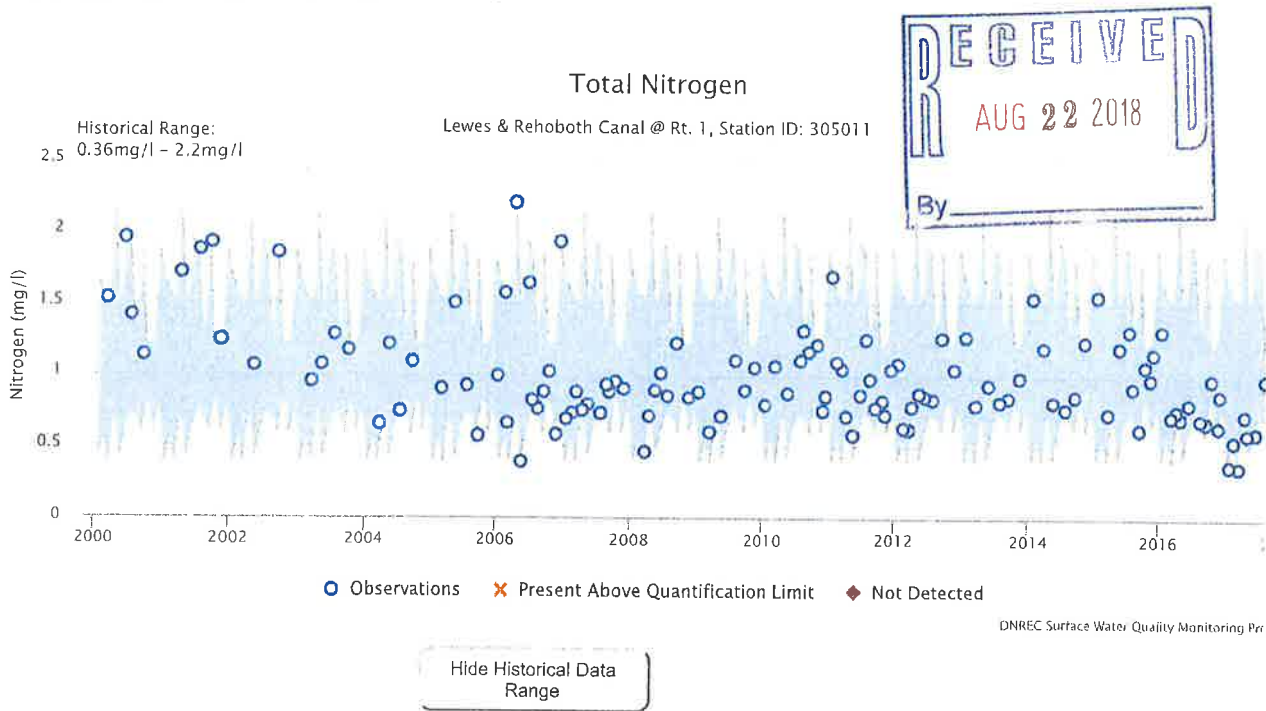

Jan	Feb	Mar	Apr	May	Jun	Jul	Aug	Sep	Oct	Nov	Dec
-----	-----	-----	-----	-----	-----	-----	-----	-----	-----	-----	-----

Min	0.37	0.54	0.36	0.71	0.39	0.6	0.73	0.69	0.57	0.82	0.58	0.75
Avg	0.59	0.65	0.57	0.81	0.71	0.76	1.04	0.94	0.91	0.99	0.75	0.92
Max	1.69	1.57	1.53	2.2	1.51	2.58	1.87	1.31	1.92	1.21	1.24	1.93

Total Phosphorus (P)

Phosphorus is a nutrient and is an essential element for both plants and animals. However, presence of excessive amounts of phosphorus in surface waters causes undesirable conditions leading to nutrient overenrichment. Symptoms of nutrient overenrichment include excessive algal blooms, large daily swings in dissolved oxygen levels, loss of Submerged Aquatic Vegetation (SAV), and fish kills.

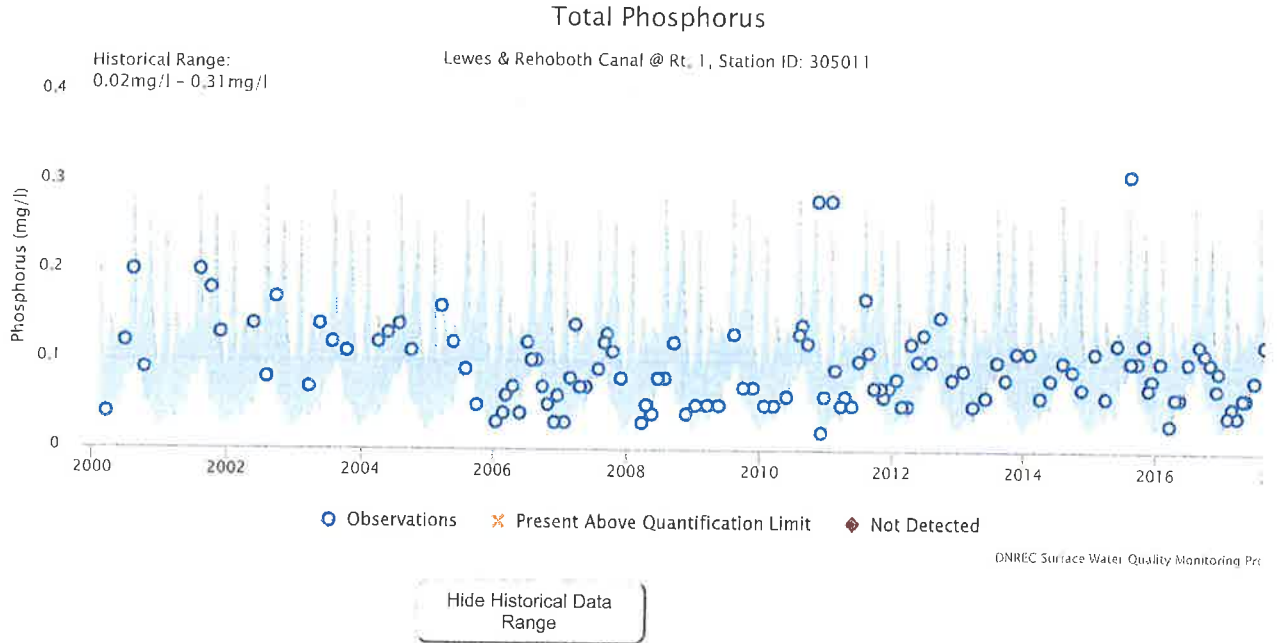

	Jan	Feb	Mar	Apr	May	Jun	Jul	Aug	Sep	Oct	Nov	Dec
Min	0.03	0.04	0.03	0.05	0.04	0.08	0.08	0.1	0.05	0.05	0.03	0.02
Avg	0.05	0.05	0.05	0.06	0.07	0.09	0.14	0.12	0.11	0.11	0.07	0.08
Max	0.28	0.09	0.16	0.12	0.14	0.13	0.31	0.14	0.18	0.28	0.13	0.09

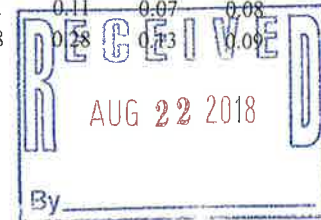

Enterococcus (Ent)

Enterococcus bacteria are indicator bacteria associated with warm blooded animals. Their presence in surface waters in excessive amount increases the risk of gastrointestinal illness for people who conduct swimming and other water contact activities in marine and fresh waters.

Enterococcus

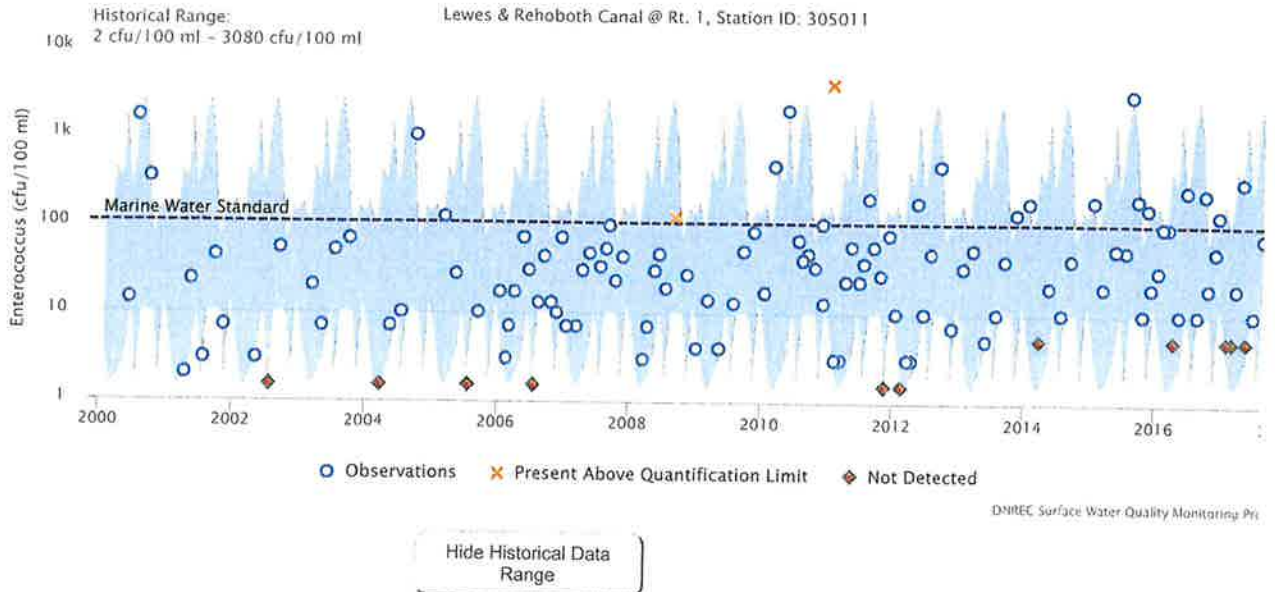

	Jan	Feb	Mar	Apr	May	Jun	Jul	Aug	Sep	Oct	Nov	Dec
Min	4	3	3	2	3	10	3	10	10	10	7	13
Avg	23.8	6	19	131.6	27.3	12.5	30	60.3	114.9	21.7	43.1	109.6
Max	189	98	460	323	2000	256	1633	3080	1000	67	158	135

Salinity (Sal)

The concentration of salt, or salinity, is a function of the mixing of freshwater with ocean waters, which has higher salinity. In any given location, salinity can vary greatly depending upon river flow: being low during high flows and high during low flows and droughts. Most of the living resources are adapted to these swings in salinity, but extreme floods or droughts can lead to stressful conditions. Extended periods of high salinity can also force fish that prefer lower salinities, such as yellow perch, out of the river mainstems and up into headwater creeks.

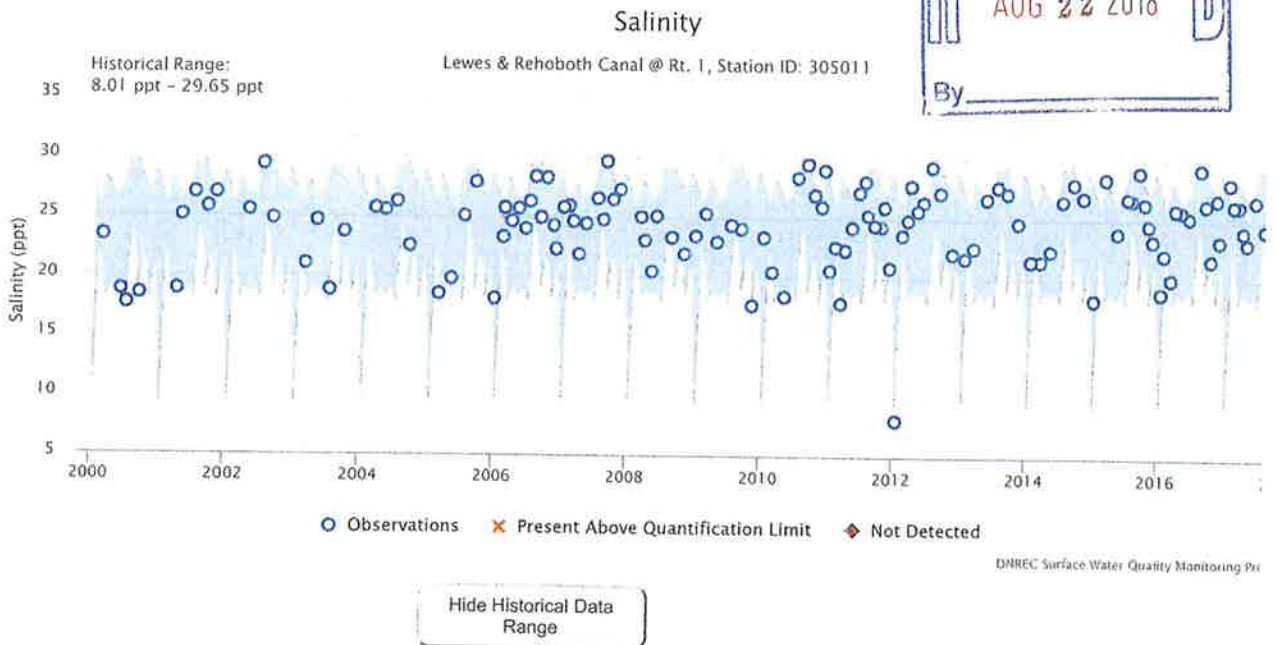

	Jan	Feb	Mar	Apr	May	Jun	Jul	Aug	Sep	Oct	Nov	Dec
Min	8.01	22.04	17.83	18.8	18.38	18.7	17.6	24.18	18.4	21.65	17.61	20.84
Avg	25.88	25.55	24.81	23.83	23.34	26.1	25.87	24.99	25.82	23.04	25.8	23.44
Max	28.08	26.2	28.4	27.73	26.65	27.13	29.33	29.26	29.65	28.24	27.29	29.01

Total Suspended Solids (TSS)

Total Suspended Solids are solid materials that are suspended in the water. Solid materials include inorganic and organic material such as silt, municipal and industrial wastes, and algae. High concentrations of suspended solids can degrade water quality by absorbing light, which causes the water to become warmer and reduces its ability to hold oxygen necessary for aquatic life. The combination of warmer water, less light and less oxygen makes it impossible for some forms of life to exist.

Suspended solids affect aquatic life in other ways. They can clog fish gills, reduce growth rates, decrease resistance to disease, and prevent egg and larval development. Particles that settle out can smother fish eggs and those of aquatic insects, as well as suffocate newly-hatched larvae. The material that settles also fills the spaces between rocks and makes these microhabitats unsuitable for various aquatic insects, such as mayfly, stonefly, and caddisfly larva.

Suspended solids can result from erosion from urban runoff and agricultural land, industrial wastes, bank erosion, bottom feeders (such as carp), algae growth or wastewater discharges. Protection of the land in our watersheds from erosion by use of conservation practices and giving urban runoff time to settle out before reaching our surface waters help with reducing suspended solids in our State's waterways.

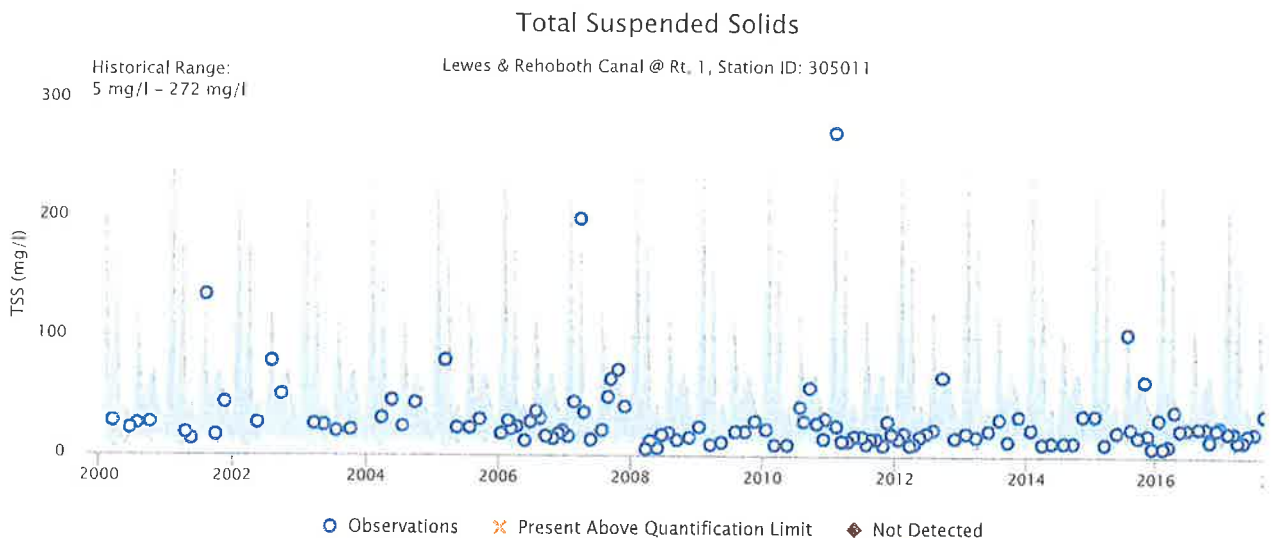

Hide Historical Data
Range



	Jan	Feb	Mar	Apr	May	Jun	Jul	Aug	Sep	Oct	Nov	Dec
Min	14	7	5	10	6	16	10	14	11	9	15	7
Avg	27.9	22	21.7	14.9	18.3	20.1	40.8	33.1	28.3	19.1	24.9	24
Max	272	45	199	38	46	28	135	49	66	72	44	31

Chlorophyll A

Chlorophyll is a color pigment found in plants, algae and phytoplankton. This molecule is used in photosynthesis, as a photoreceptor. There are 6 different chlorophylls that have been identified. The different forms (A, B, C, D, E and F) each reflect slightly different ranges of green wavelengths. Chlorophyll A is the primary molecule responsible for photosynthesis. Chlorophyll is measured in micrograms per liter ($\mu\text{g/l}$).

Chlorophyll A

Lewes & Rehoboth Canal @ Rt. 1, Station ID: 305011

Historical Range:
1 µg/l - 56.1 µg/l

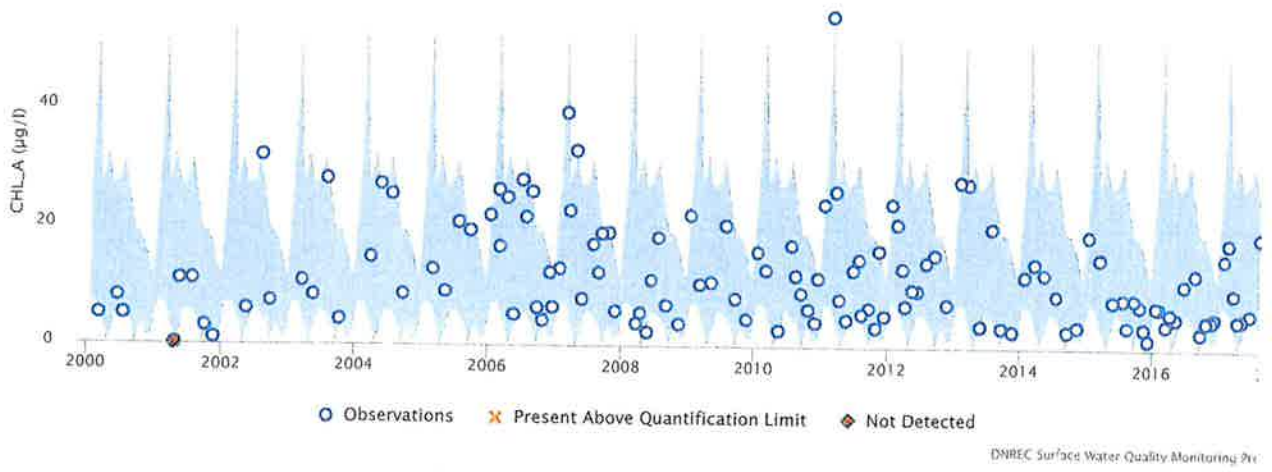

Hide Historical Data Range

	Jan	Feb	Mar	Apr	May	Jun	Jul	Aug	Sep	Oct	Nov	Dec
Min	6.97	6.89	3.7	4.75	2.23	5.88	5	3.63	2.65	3.23	1	1.48
Avg	16.23	21.45	11.62	7.09	6.39	7.64	17.34	17.18	6.45	5.44	5.23	5.33
Max	27.9	56.1	27.5	32.9	27.1	27.9	32	25.9	19.3	19	16.2	11.5



This site was developed by the Delaware Environmental Observing System and the Delaware Environmental Monitoring & Analysis Center in coordination with the DNREC Watershed Assessment Section. All data for this site were obtained from the National Water Quality Monitoring Council's National Water Quality Portal (www.waterqualitydata.us).



EXHIBIT 2

Permit Drawings

“Proposed Oyster House Village Community Dock”

Prepared by Solutions IPEM. LLC.



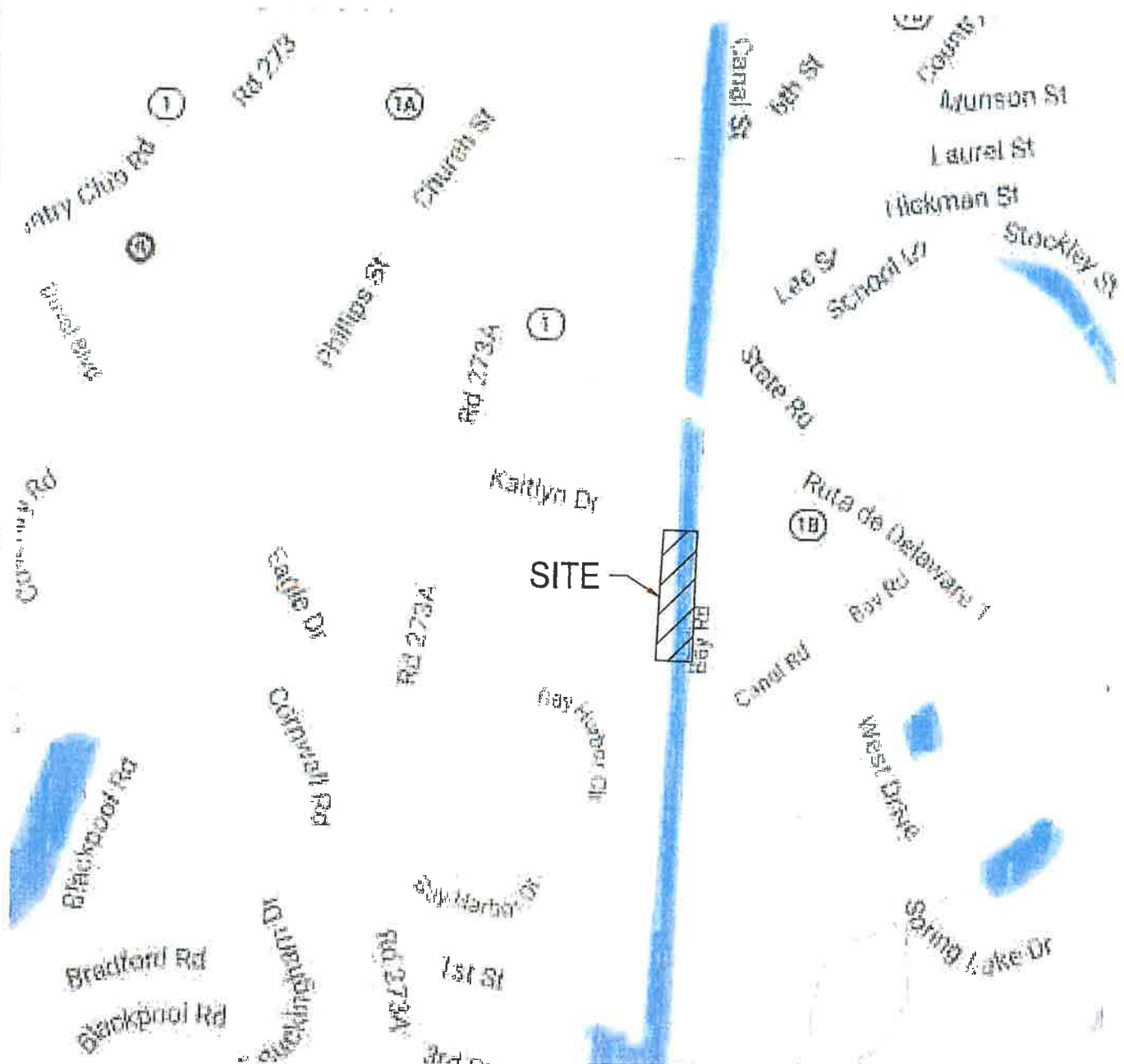
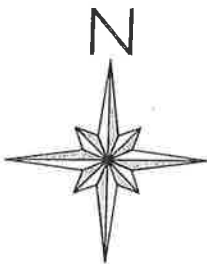

SITE

VICINITY MAP
PROPOSED COMMUNITY DOCK
AT
OYSTER HOUSE VILLAGE



TAX MAP 334-19.00-173.00
LEWES REHOBOTH HUNDRED
SUSSEX COUNTY, DELAWARE

FEBRUARY 14, 2018

SCALE: N.T.S.

SHEET 1 OF 8

solutions

Integrated Planning
Engineering & Management, LLC

303 North Bedford Street
Georgetown, DE 19947
T. 302.297.9215
www.solutionsipem.com
Copyright © 2018

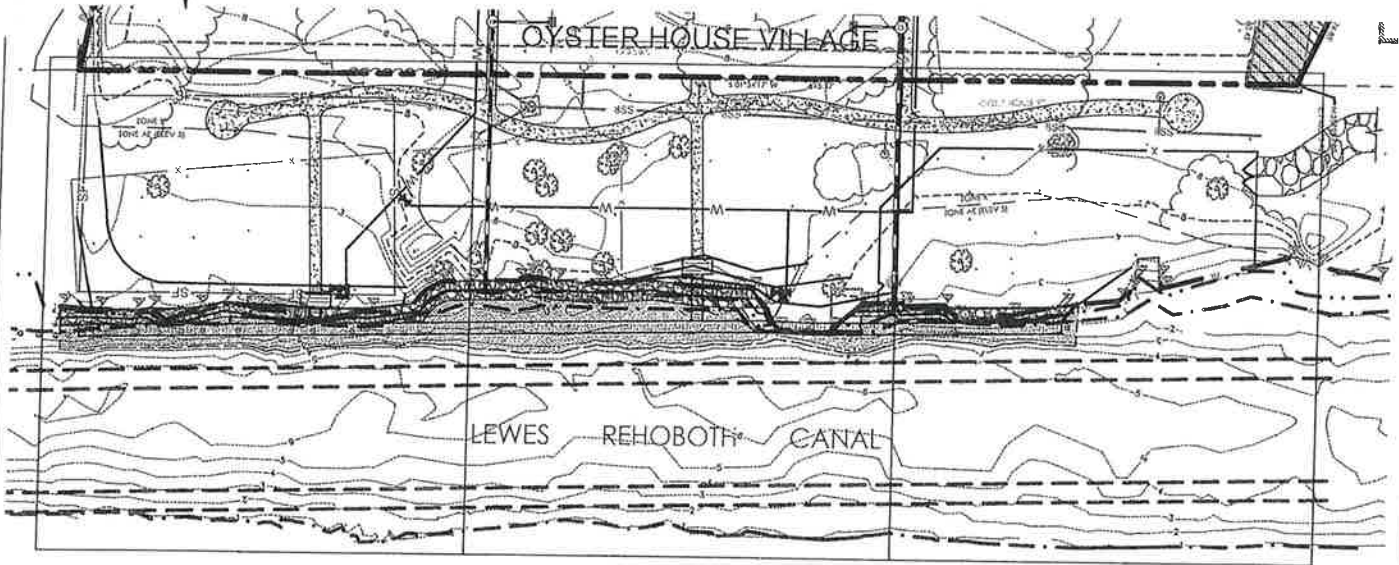
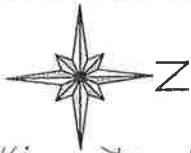

SHEET 3

SHEET 4

SHEET 5

IMPACT TABLE

KEY MAP

PROPOSED STRUCTURES

PROPOSED 6' WIDE DOCK	= 540 L.F.±
PROPOSED ACCESS PIERS OVER WATER	= 17 L.F.±
MAXIMUM NUMBER OF VESSELS	= 20

PROPOSED RIPRAP FILL AREAS IN WATERS OF THE U.S.

ABOVE MEAN HIGH WATER	= 2,230 S.F.±
MEAN HIGH WATER TO MEAN LOW WATER	= 1,800 S.F.±
CHANNELWARD OF MEAN LOW WATER	= 30 S.F.±

DREDGE QUANTITIES

AREA OF PROPOSED DREDGING	= 7,275 S.F.±
VOLUME OF PROPOSED DREDGING	= 300 C.Y.±

LEGEND

	EXISTING
PROPERTY LINE	— — — — —
BOUNDARY OF WATERS OF THE U.S.	— √ — — — —
MEAN HIGH WATER	— · · — — —
MEAN LOW WATER	— - - - -
FEDERAL CHANNEL	— · — — —
SALTMARSH GRASS	□ · · · · ·
SPOT ELEVATION	* 2.72
TREE	🌳

	EXISTING	PROPOSED
CONTOUR	--- 3 ---	— 3 —
FENCE	— x —	— x —
DOCK / PIER		▨
GRAVEL ACCESS DRIVE		▨
PATH		▨
RIPRAP BANK		▨
LIMITS OF DREDGING		▨
STORMDRAIN OUTFALL PIPE		▨
SILT FENCE		— SF —



**KEY MAP & IMPACT TABLE
PROPOSED COMMUNITY DOCK
AT
OYSTER HOUSE VILLAGE**

TAX MAP 334-19.00-173.00
LEWES REHOBOTH HUNDRED
SUSSEX COUNTY, DELAWARE

FEBRUARY 14, 2018

SCALE: 1"=100'

SHEET 2 OF 8

solutions
Integrated Planning
Engineering & Management, LLC

303 North Bedford Street
Georgetown, DE 19947
T. 302.297.9215
www.solutionsipem.com
Copyright © 2018

OYSTER HOUSE VILLAGE

TM 334-19.08-42.00

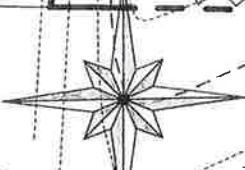

ZONE
ZONE AE (ELEV 5)

EX. FENCE TO BE
REMOVED

EX. TREES TO
REMAIN (TYP.)

MEAN HIGH
WATER
EL. = 1.2

AREA TO BE FILLED
EL. 3.2 TO 4.0 = 15,480 S.F. ±
DREDGE SPOIL WITH
TOPSOIL CAP.

FIRE
HYDRANT

LIMITS OF PROJECT AREA

EX. PILING(S) TO BE
REMOVED

EX.
PILINGS
(TYP.)

MEAN LOW
WATER
EL. = -0.8

FILL RIPRAP BANK.
SEE SECTION A

PROPOSED
KAYAK
LAUNCH
LADDER

520 L.F. OF 6' WIDE
DOCK, EL. 3.5

EX. SALT MARSH
GRASS

LEWES REHOBOTH CANAL

LIMITS OF DREDGING
DOCK AND LOT
GRADING

SEE SHEET 4

PLAN VIEW SOUTH

PROPOSED COMMUNITY DOCK
AT
OYSTER HOUSE VILLAGE

TAX MAP 334-19.00-173.00
LEWES REHOBOTH HUNDRED
SUSSEX COUNTY, DELAWARE



FEBRUARY 14, 2018

SCALE: 1"=30'

SHEET 3 OF 8

solutions

Integrated Planning
Engineering & Management, LLC

303 North Bedford Street
Georgetown, DE 19947
T. 302.297.9215
www.solutionsipem.com
Copyright © 2018

OYSTER HOUSE VILLAGE

TM 334-19.08-42.00

S 01°54'17" W 645.47'

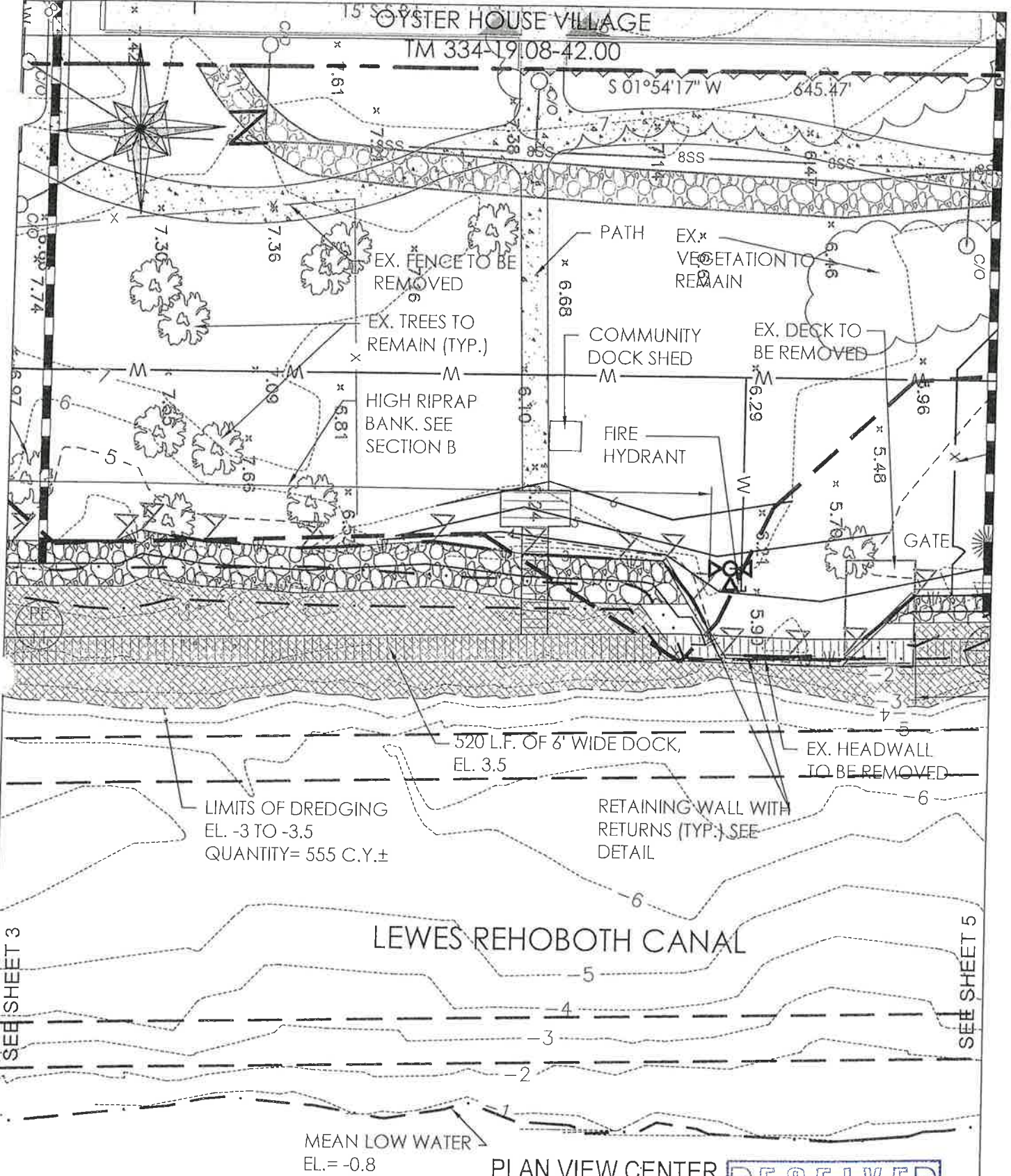

SEE SHEET 3

SEE SHEET 5

LEWES REHOBOTH CANAL

MEAN LOW WATER
EL. = -0.8

PLAN VIEW CENTER

PROPOSED COMMUNITY DOCK
AT
OYSTER HOUSE VILLAGE

TAX MAP 334-19.00-173.00
LEWES REHOBOTH HUNDRED
SUSSEX COUNTY, DELAWARE



FEBRUARY 14, 2018

SCALE: 1"=30'

SHEET 4 OF 8

solutions
 Integrated Planning
 Engineering & Management, LLC

303 North Bedford Street
 Georgetown, DE 19947
 T. 302.297.9215
 www.solutionsipem.com
 Copyright © 2018

OYSTER HOUSE VILLAGE

TM 334-19,08-42.00

27.43

OYSTER HOUSE RD

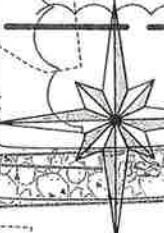

EX. EASEMENT 3
PERMANENT EASEMENT
DB 4554/275

ZONE X
ZONE SE (ELEV 5)

FUTURE DNREC WATERWAY
MANAGEMENT COMPOUND

LIMITS OF PROJECT
AREA

EX. PILING
TO BE
REMOVED

EX. BOAT
RAMP

10' CHANNEL BUFFER

LOW RIPRAP
BANK. SEE
SECTION C

LIMIT OF DOCK
LIMITS OF DREDGING

EXISTING FEDERAL
CHANNEL

LEWES REHOBOTH CANAL

10' CHANNEL BUFFER

PLAN VIEW NORTH

PROPOSED COMMUNITY DOCK
AT
OYSTER HOUSE VILLAGE

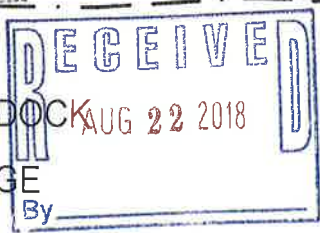

TAX MAP 334-19.00-173.00
LEWES REHOBOTH HUNDRED
SUSSEX COUNTY, DELAWARE

FEBRUARY 14, 2018

SCALE: 1"=30'

SHEET 5 OF 8

solutions
Integrated Planning
Engineering & Management, LLC

303 North Bedford Street
Georgetown, DE 19947
T. 302.297.9215
www.solutionsipem.com
Copyright © 2018

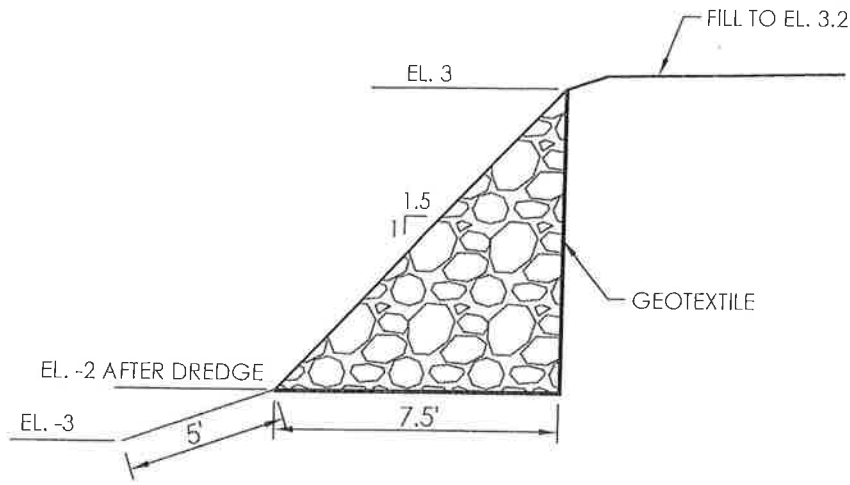

FILL RIPRAP BANK SECTION A

N.T.S.

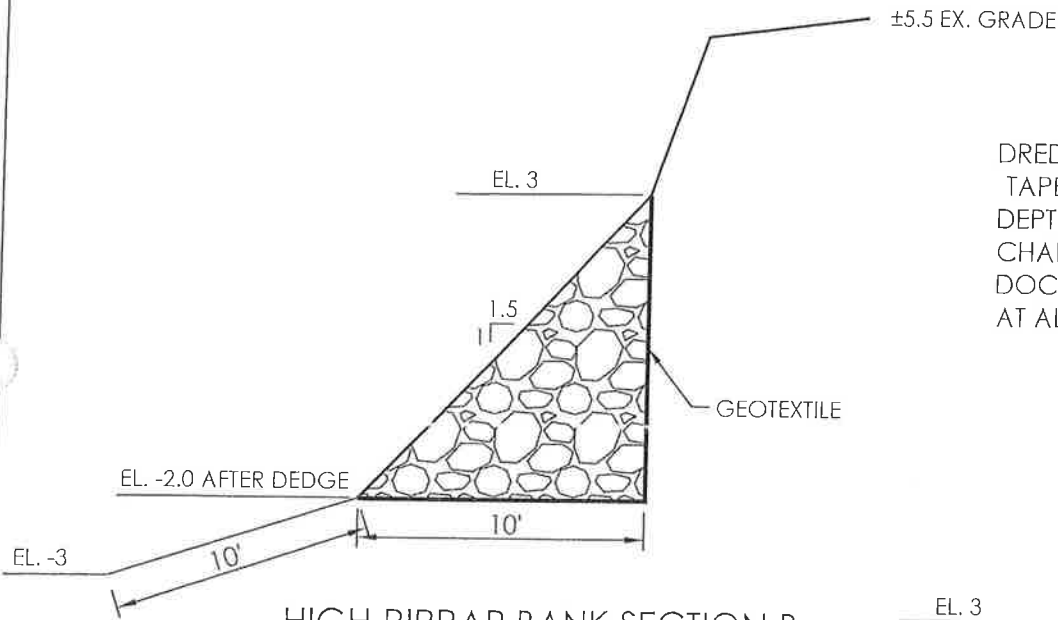

HIGH RIPRAP BANK SECTION B

N.T.S.

DREDGING NOTE:
TAPER TO PROVIDE
DEPTH OF -3.5 FEET
CHANNELWARD OF
DOCK WHERE POSSIBLE
AT ALL LOCATIONS.

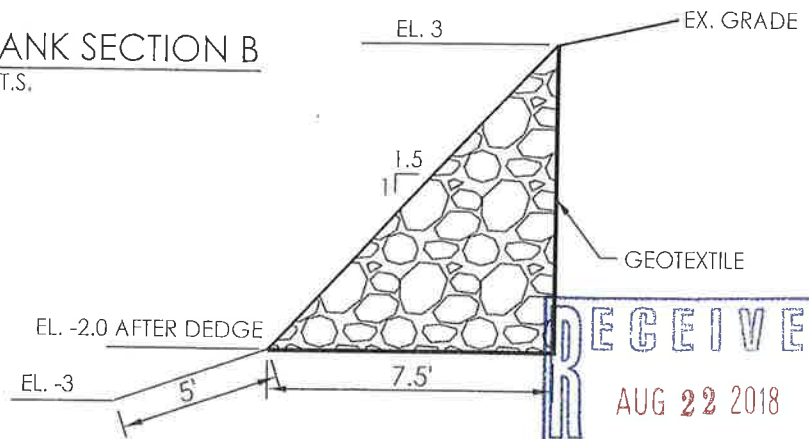

LOW RIPRAP BANK SECTION C

N.T.S.

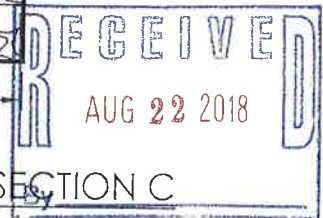

**PROPOSED COMMUNITY DOCK
AT
OYSTER HOUSE VILLAGE**

TAX MAP 334-19.00-173.00
LEWES REHOBOTH HUNDRED
SUSSEX COUNTY, DELAWARE

FEBRUARY 14, 2018

SCALE: N.T.S.

SHEET 6 OF 8

303 North Bedford Street
Georgetown, DE 19947
T. 302.297.9215
www.solutionsipem.com
Copyright © 2018

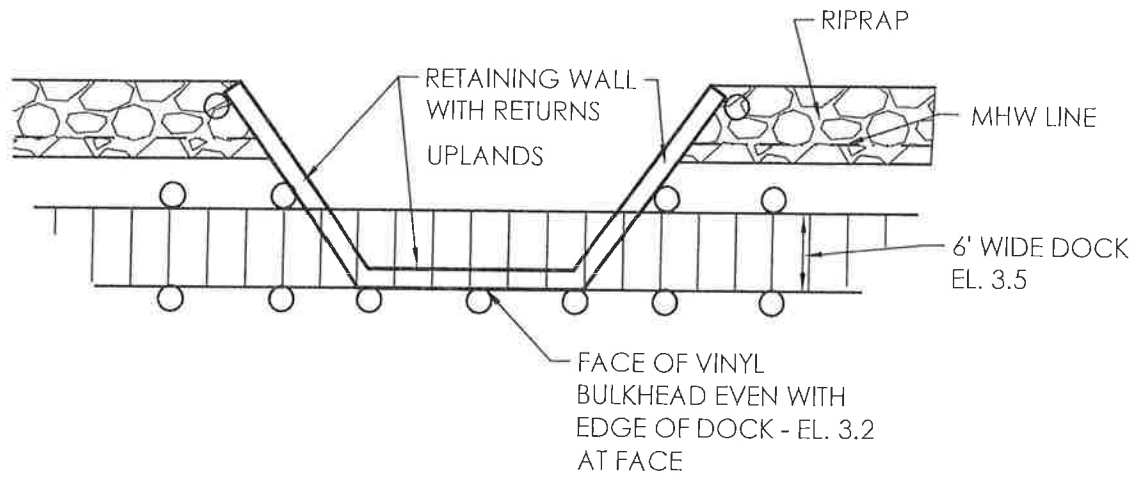

RETAINING WALL DETAIL

N.T.S.

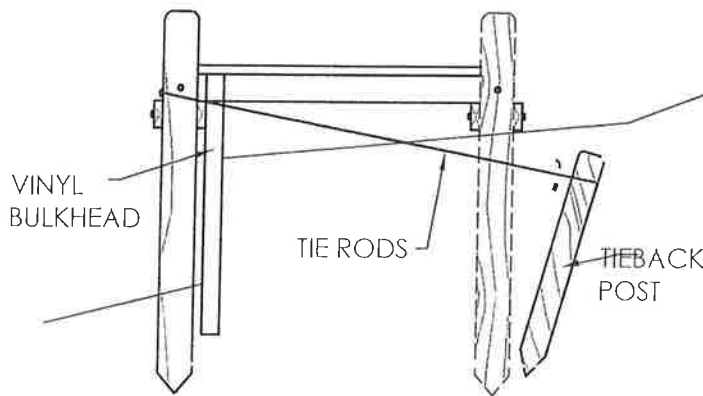

VINYL BULKHEAD DETAIL

N.T.S.

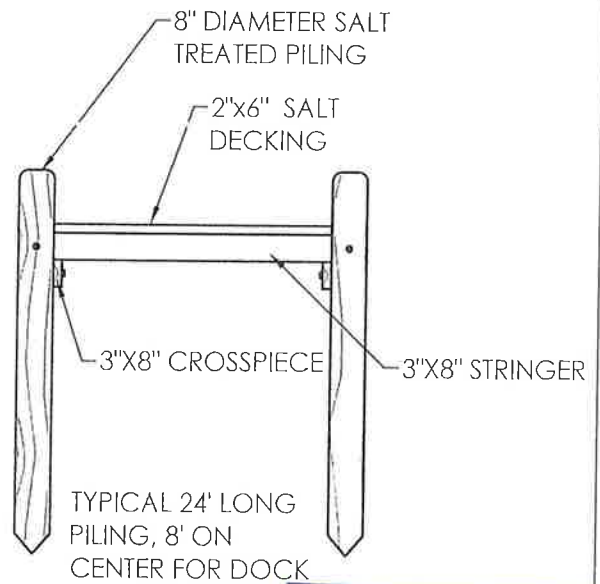

DOCK DETAIL

N.T.S.



PROPOSED COMMUNITY DOCK
AT
OYSTER HOUSE VILLAGE

TAX MAP 334-19.00-173.00
LEWES REHOBOTH HUNDRED
SUSSEX COUNTY, DELAWARE

FEBRUARY 14, 2018

SCALE: N.T.S.

SHEET 7 OF 8

solutions
Integrated Planning
Engineering & Management, LLC

303 North Bedford Street
Georgetown, DE 19947
T. 302.297.9215
www.solutionsipem.com
Copyright © 2018

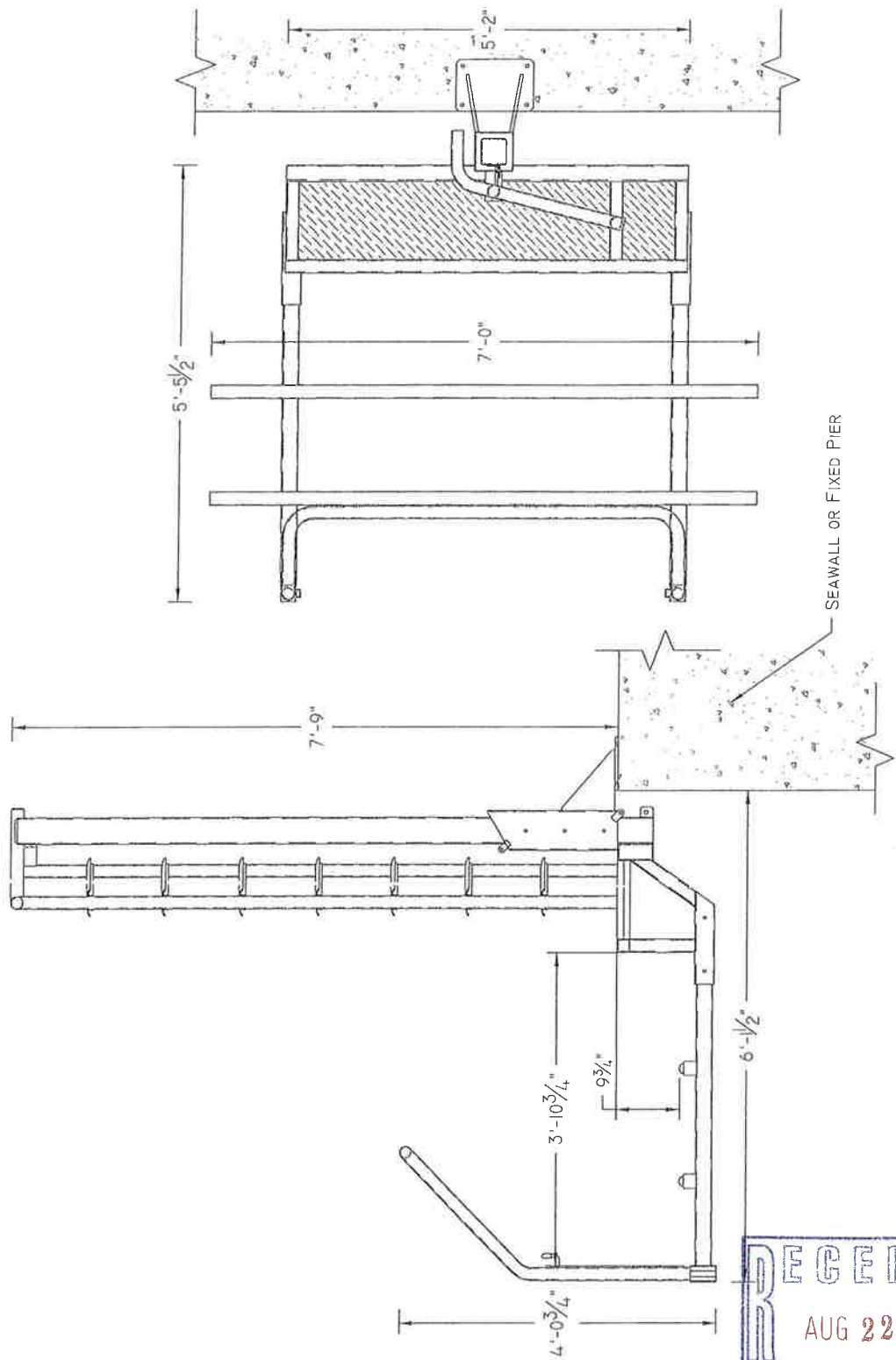

PROPOSED KAYAK LAUNCH LADDER DETAIL
N.T.S.

RECEIVED
AUG 22 2018
By _____

PROPOSED COMMUNITY DOCK
AT
OYSTER HOUSE VILLAGE

TAX MAP 334-19.00-173.00
LEWES REHOBOTH HUNDRED
SUSSEX COUNTY, DELAWARE

FEBRUARY 14, 2018

SCALE: N.T.S.

SHEET 8 OF 8

 Integrated Planning
 Engineering & Management, LLC
 303 North Bedford Street
 Georgetown, DE 19947
 T. 302.297.9215
 www.solutionsipem.com
 Copyright © 2018

EXHIBIT 3

USFWS
Threatened & Endangered Species List





United States Department of the Interior



FISH AND WILDLIFE SERVICE
Chesapeake Bay Ecological Services Field Office
177 Admiral Cochrane Drive
Annapolis, MD 21401-7307
Phone: (410) 573-4599 Fax: (410) 266-9127

<http://www.fws.gov/chesapeakebay/>
<http://www.fws.gov/chesapeakebay/endsppweb/ProjectReview/Index.html>

In Reply Refer To:
Consultation Code: 05E2CB00-2018-SLI-1758
Event Code: 05E2CB00-2018-E-03870
Project Name: Oyster House Village

August 20, 2018

Subject: List of threatened and endangered species that may occur in your proposed project location, and/or may be affected by your proposed project

To Whom It May Concern:

The enclosed species list identifies threatened, endangered, proposed and candidate species, as well as proposed and final designated critical habitat, that may occur within the boundary of your proposed project and/or may be affected by your proposed project. This species list fulfills the requirements of the U.S. Fish and Wildlife Service (Service) under section 7(c) of the Endangered Species Act (Act) of 1973, as amended (16 U.S.C. 1531 *et seq.*).

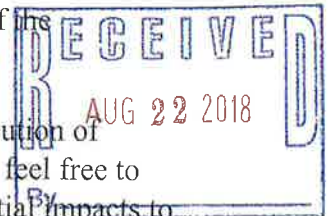

New information based on updated surveys, changes in the abundance and distribution of species, changed habitat conditions, or other factors could change this list. Please feel free to contact us if you need more current information or assistance regarding the potential impacts to federally proposed, listed, and candidate species and federally designated and proposed critical habitat. Please note that under 50 CFR 402.12(e) of the regulations implementing section 7 of the Act, the accuracy of this species list should be verified after 90 days. This verification can be completed formally or informally as desired. The Service recommends that verification be completed by visiting the ECOS-IPaC website at regular intervals during project planning and implementation for updates to species lists and information. An updated list may be requested through the ECOS-IPaC system by completing the same process used to receive the enclosed list.

The purpose of the Act is to provide a means whereby threatened and endangered species and the ecosystems upon which they depend may be conserved. Under sections 7(a)(1) and 7(a)(2) of the Act and its implementing regulations (50 CFR 402 *et seq.*), Federal agencies are required to utilize their authorities to carry out programs for the conservation of threatened and endangered species and to determine whether projects may affect threatened and endangered species and/or designated critical habitat.

A Biological Assessment is required for construction projects (or other undertakings having similar physical impacts) that are major Federal actions significantly affecting the quality of the human environment as defined in the National Environmental Policy Act (42 U.S.C. 4332(2)(c)). For projects other than major construction activities, the Service suggests that a biological evaluation similar to a Biological Assessment be prepared to determine whether the project may affect listed or proposed species and/or designated or proposed critical habitat. Recommended contents of a Biological Assessment are described at 50 CFR 402.12.

If a Federal agency determines, based on the Biological Assessment or biological evaluation, that listed species and/or designated critical habitat may be affected by the proposed project, the agency is required to consult with the Service pursuant to 50 CFR 402. In addition, the Service recommends that candidate species, proposed species and proposed critical habitat be addressed within the consultation. More information on the regulations and procedures for section 7 consultation, including the role of permit or license applicants, can be found in the "Endangered Species Consultation Handbook" at:

<http://www.fws.gov/endangered/esa-library/pdf/TOC-GLOS.PDF>

Please be aware that bald and golden eagles are protected under the Bald and Golden Eagle Protection Act (16 U.S.C. 668 *et seq.*), and projects affecting these species may require development of an eagle conservation plan (http://www.fws.gov/windenergy/eagle_guidance.html). Additionally, wind energy projects should follow the wind energy guidelines (<http://www.fws.gov/windenergy/>) for minimizing impacts to migratory birds and bats.

Guidance for minimizing impacts to migratory birds for projects including communications towers (e.g., cellular, digital television, radio, and emergency broadcast) can be found at: <http://www.fws.gov/migratorybirds/CurrentBirdIssues/Hazards/towers/towers.htm>; <http://www.towerkill.com>; and <http://www.fws.gov/migratorybirds/CurrentBirdIssues/Hazards/towers/comtow.html>.

We appreciate your concern for threatened and endangered species. The Service encourages Federal agencies to include conservation of threatened and endangered species into their project planning to further the purposes of the Act. Please include the Consultation Tracking Number in the header of this letter with any request for consultation or correspondence about your project that you submit to our office.

Attachment(s):

- Official Species List
- USFWS National Wildlife Refuges and Fish Hatcheries
- Wetlands



Official Species List

This list is provided pursuant to Section 7 of the Endangered Species Act, and fulfills the requirement for Federal agencies to "request of the Secretary of the Interior information whether any species which is listed or proposed to be listed may be present in the area of a proposed action".

This species list is provided by:

Chesapeake Bay Ecological Services Field Office

177 Admiral Cochrane Drive

Annapolis, MD 21401-7307

(410) 573-4599



Project Summary

Consultation Code: 05E2CB00-2018-SLI-1758

Event Code: 05E2CB00-2018-E-03870

Project Name: Oyster House Village

Project Type: DEVELOPMENT

Project Description: Development of 30 home residential Community and Community Dock

Project Location:

Approximate location of the project can be viewed in Google Maps: <https://www.google.com/maps/place/38.70605439083424N75.09420394021393W>

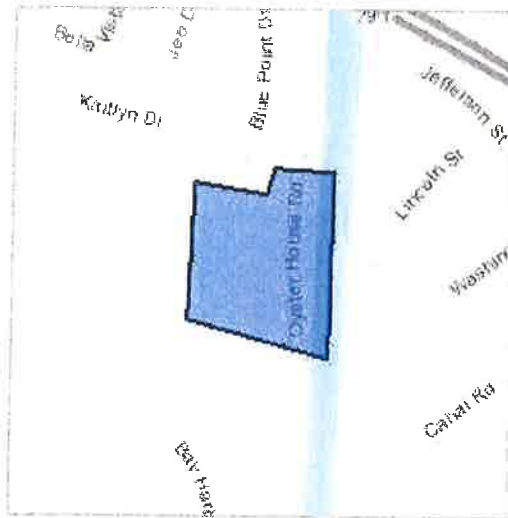

Counties: Sussex, DE

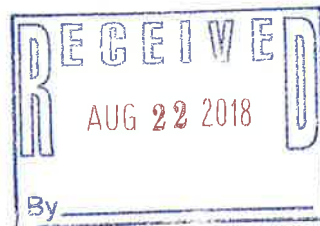

Endangered Species Act Species

There is a total of 0 threatened, endangered, or candidate species on this species list.

Species on this list should be considered in an effects analysis for your project and could include species that exist in another geographic area. For example, certain fish may appear on the species list because a project could affect downstream species.

IPaC does not display listed species or critical habitats under the sole jurisdiction of NOAA Fisheries¹, as USFWS does not have the authority to speak on behalf of NOAA and the Department of Commerce.

See the "Critical habitats" section below for those critical habitats that lie wholly or partially within your project area under this office's jurisdiction. Please contact the designated FWS office if you have questions.

-
1. [NOAA Fisheries](#), also known as the National Marine Fisheries Service (NMFS), is an office of the National Oceanic and Atmospheric Administration within the Department of Commerce.

Critical habitats

THERE ARE NO CRITICAL HABITATS WITHIN YOUR PROJECT AREA UNDER THIS OFFICE'S JURISDICTION.

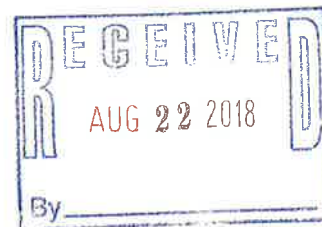

USFWS National Wildlife Refuge Lands And Fish Hatcheries

Any activity proposed on lands managed by the National Wildlife Refuge system must undergo a 'Compatibility Determination' conducted by the Refuge. Please contact the individual Refuges to discuss any questions or concerns.

THERE ARE NO REFUGE LANDS OR FISH HATCHERIES WITHIN YOUR PROJECT AREA.



Wetlands

Impacts to NWI wetlands and other aquatic habitats may be subject to regulation under Section 404 of the Clean Water Act, or other State/Federal statutes.

For more information please contact the Regulatory Program of the local U.S. Army Corps of Engineers District.

Please note that the NWI data being shown may be out of date. We are currently working to update our NWI data set. We recommend you verify these results with a site visit to determine the actual extent of wetlands on site.

ESTUARINE AND MARINE DEEPWATER

- E1UBL

FRESHWATER FORESTED/SHRUB WETLAND

- PFO1/4B



FIGURE 1

USGS Topographic Map



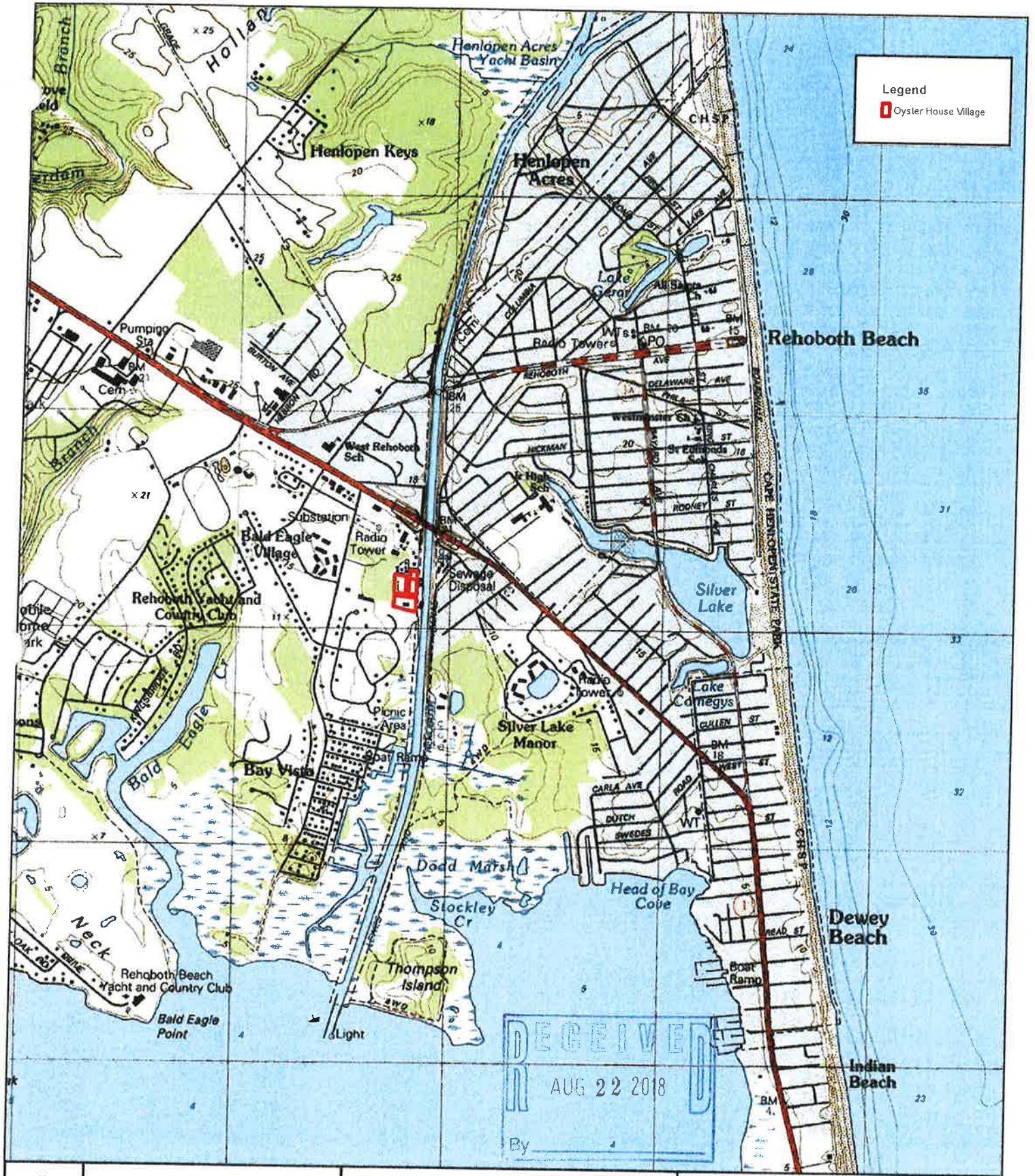

Legend
■ Oyster House Village

RECEIVED
 AUG 22 2018
 By _____



1 inch = 2,000 feet
 0 500 1,000 2,000 Feet

U.S. GEOLOGICAL SURVEY
 TOPOGRAPHIC MAP
 REHOBOTH BEACH QUAD.

OYSTER HOUSE VILLAGE
 REHOBOTH BEACH, DELAWARE
 SUSSEX COUNTY

ERI ENVIRONMENTAL
 RESOURCES, INC.

Date: 2/28/2017

Dwn.By: JLW

FIGURE:

Revisions:

Proj.No.:

1

FIGURE 2

Vicinity Map



FIGURE 3

Resource Guidance Map





Legend

- Oyster House Village
- Parcels
- Streets
- 2005 Sussex County LIDAR - Elevation
- USFWS NWI
- 2007 DE Wetlands
- SOIL SURVEY
- orthos2012

1 inch = 100 feet
0 50 100 Feet

MAPPED SITE RESOURCES
AUG 22 2018

OYSTER HOUSE VILLAGE
 REHOBOTH BEACH, DELAWARE
 SUSSEX COUNTY

ENVIRONMENTAL RESOURCES, INC.

Date:	2/28/2017	Dwn. By:	JLW
Revisions:		Proj. No.:	

FIGURE:
3

FIGURE 4

11"x17" Existing Conditions Map



OYSTER HOUSE VILLAGE COMMUNITY DOCK
OPERATION & MAINTENANCE PLAN

April 5, 2018

Prepared for:

OYSTER HOUSE VILLAGE HOMEOWNERS ASSOCIATION

c/o OHV DE LLC.
34 East Germantown Pike #203
Norristown, PA 19401

Prepared by:



ENVIRONMENTAL RESOURCES, INC.

38173 DuPont Boulevard
Post Office Box 169
Selbyville, Delaware 19975
Phone: (302) 436-9637

DRAFT

ERI Project No.: 0807#0696

BY: _____

TABLE OF CONTENTS

Introduction and Dock Site History

General Dock Information

- A) Facility Name and Address
- B) Name of Owner and Operator Including Contact Information
- C) Personnel Contact Information
- D) Emergency Numbers
 - Responsible personnel numbers (home, office, cell)
 - Emergency response team numbers (fire station, coast guard, ambulance, etc.)
 - Event Response Numbers

Part I: Dock Overview

- A) Plans
- B) Water Depths
- C) Slip Capacity and Dock Configuration
- D) MSD Types and Numbers
- E) Fueling Location, Rules and Procedures
- F) Sanitation Location and Rules
- G) Seasonal Wet Storage Reduction Plan

Part II: Pumpout Compliance

- A) Pumpout Operations and Procedures
- B) Number and Types of MSD's on Vessels
- C) Pumpout Sharing Agreement
- D) State of Delaware Pumpout Law

Part III: Stormwater Management

- A) Stormwater Management Practices/Plan

Part IV: Materials and Waste Management

- A) Handling, Storage and Disposal of Materials and Waste

Part V: Emergency Planning

- A) Responsible Personnel and Emergency Response Numbers
- B) Fuel/Oil Spill Prevention and Containment Practices
- C) Sewage Spill Prevention and Containment Practices
- D) Fire
- E) Hurricane/Severe Weather

Part VI: Dock Rules and Regulations and General Guidance

- A) Dock Rules and Regulations for Boaters
- B) Oyster House Village Community Dock Clean Dock Boating Tips
- C) State of Delaware Fish Waste Policy

DRAFT



BY: _____

INTRODUCTION

OHV DE LLC (owner) wishes to construct and operate a 20-slip community dock and associated shoreline improvements along the Lewes Rehoboth Canal. The facility will be operated by OHV DE LLC until the completion of the Oyster House Village. Upon completion, The Oyster House Village Homeowners Association, Inc. (Homeowners Association (HOA)) will assume management of the facility. Permits for the proposed dock have been submitted to state and federal resource agencies. The facility will consist of a 520 foot long dock with the capability of mooring a maximum of 20 boats. A kayak launch ladder is proposed along the dock. The owner has also requested a license from the Corps of Engineers Real Estate Division to construct and operate the facility. Use of the 20 slip community dock will be limited to residents of the Oyster House Village community. A portable marine pumpout station will be situated adjacent to the community dock. In addition, signage with dock rules will be located at a small land based storage building, housing the portable marine pumpout station and spill kit.

In order to comply with requirements and future permit conditions of authorizations pending from the Delaware Department of Natural Resources & Environmental Control (DNREC), Wetlands and Subaqueous Lands Section (WSLS), this Operation and Maintenance Plan (O&M Plan) has been developed. The O&M Plan serves to describe the facility, define how the facility will be operated utilizing best management practices (BMPs), and provide rules and procedures for users of the facility. The goal of the O&M Plan is to protect the water quality of the Lewes Rehoboth Canal and to ensure that the Dock is operated in a safe manner. *Please note this O&M Plan may be revised upon based upon receipt of a DNREC, WSLS Permit, should there be any potential unknown permit special conditions.*

The owner/operator of the Dock facility is required to:

1. Update and submit the O&M Plan to DNREC, WSLS for re-approval every four (4) years from the date DNREC approves the facility as fit for operation, or upon transfer of ownership of the facility;
2. Ensure that the facility is operated and maintained as specified by the DNREC-approved O&M Plan and in a manner which protects the health, safety and welfare of dock employees, tenants and members of the general public;
3. Ensure that the facility is operated in compliance with the conditions of DNREC and any U.S. Army Corps of Engineers permits;
4. Ensure that dock tenants comply with the O&M Plan;
5. Provide copies of the O&M Plan to all dock tenants; and
6. Take appropriate action to deal with dock tenants who violate the O&M Plan.

DRAFT

RECEIVED
JUN 1 2018

GENERAL DOCK INFORMATION

A) Facility Name and Address

Oyster House Village Community Dock
Oyster House Road, Rehoboth Beach, Delaware 19971
Parcel: 173.00 Tax Map: 334-19.00
Lewes Rehoboth Hundred, Sussex County, Delaware

B) Name of Owner

OHV DE LLC
C/O Mr. Keith Delaney (484) 322-5440
34 East Germantown Pike #203
Norristown, Pennsylvania 19401

C) Operator & Personnel Contact Information

Harbormaster/Oyster House Village Community Dock Office No.: (484) 322-5440
C/O Mr. Keith Delaney
34 East Germantown Pike #203
Norristown, Pennsylvania 19401

D) Emergency Numbers

Responsible Personnel:

Oyster House Village Community Dock Harbormaster (484) 322-5440
Mr. Keith Delaney

Emergency Response Numbers:

Police/Fire/Ambulance 911
U.S. Coast Guard Search & Rescue (757) 398-6700
DNREC Emergency Response Team/Conservation Officer (800) 662-8802

In the event of a fuel, oil or sewage spill or fire, reporting contact numbers are:

Oyster House Village Community Dock Harbormaster (484) 322-5440
Owner (484) 322-5440
Police/Medical/Fire Emergency 911
Local Fire Company – Rehoboth Beach (302) 227-8400
State Police (Non-emergency, Troop 7, Lewes DE) (302) 644-5020
U.S. Coast Guard (Indian River Inlet, DE) (302) 227-2439
DNREC Emergency Response Team/Dock Police (800) 662-8802
DNREC Inland Bays Pollution Reporting Hotline (800) 523-3336
Sussex County Operations Center (severe weather) (302) 855-7801

DRAFT

RECEIVED
APR 10 2018

PART I: DOCK OVERVIEW

A) Plans

Plans sized at 8.5-inch by 11-inch for the community dock facility as currently proposed are included in *Appendix A* of this O&M Plan.

B) Water Depths

Local Range of Tides

Elevation: +/-1.2' mean high water

Elevation: 0.0' North American Vertical Datum of 1988 (NAVD 88)

Elevation: -0.8' mean low water

Elevation of community pier: $\pm 3.5'$

Design depth of Dock

Elevation: -3.0' to -3.5' (NAVD 88)

C) Slip Capacity and Dock Configuration

Twenty-(20) recreational wet slip berths parallel mooring to 520' long community dock.

One (1) 4 x 8 kayak launch ladder

One (1), six (6) feet by 24 feet access pier to the mainland.

One (1), six (6) by eight (8) feet access pier to the mainland.

One (1) marina storage building which includes spill containment equipment, fire extinguisher, and life ring station, portable marine pump out station, and signage at the entrance to the community dock.

D) MSD Types and Numbers

Unknown at this time, records may be kept by operator based upon future community dock tenant records.

E) Fueling Location, Rules and Procedures

The community dock does not contain fueling facilities.

Community dock tenants are advised that fueling by commercial distributors is not permitted without permission and direct supervision by the Harbormaster who oversees safety precautions.

When fuel is carried onboard, it should only be done so in an approved container or in a portable tank as provided for outboard engines, and should be safely stowed outside of engine or living compartments.

Fueling should not be done at night except under well-lighted conditions.

The quantity of fuel to be taken aboard vessel in fuel tanks should be determined beforehand in order to avoid overfilling.

DRAFT

RECEIVED
MAR 1 2008

BY: _____

Tanks should never be completely filled. A minimum of 10 percent of tank space should be allowed for fuel expansion.

After fueling, any spillage should be wiped up. Place contaminated material in a sealed plastic bag, then dispose of onshore in the dock trash dumpster.

F) Sanitation Location and Rules

A restroom for the use of the Oyster House Village Community Dock tenants and guests is located at the community clubhouse. A sewage pumpout station for vessels is located in the marina storage building adjacent to the community dock. Community dock tenants shall use the shore side bathroom facilities at their homes or at the community clubhouse at all times while docked at the marina.

Tenants are advised by this O&M Plan that the discharge, by any means, of untreated or inadequately treated vessel sewage into or upon the waters of any dock, boat docking facility or tidal water of the State of Delaware is strictly prohibited by Delaware law. Violation is punishable by a minimum \$1,000 fine and up to a \$25,000 fine per violation.

G) Seasonal Wet Storage Reduction Plan

The Oyster House Village Community Dock is not expected to moor live-aboard vessels or vessels which would otherwise require year-round mooring. Removal of vessels or any subsequently authorized jet ski floats for winter storage will be encouraged by September 10. Spring launching will be encouraged after April 1. No boat docking will be permitted at any time on the portion of the pier north of the north access pier (northern 200' section of dock) from September 10 through March 31 of any calendar year. This portion of dock shall be made available to the DNREC Water Management Section to facilitate their seasonal dredging operations.

Special provisions for maintaining vessels within the dock for sporting or other similar purposes will be on a case-by-case basis with the permission of the Harbormaster. Any vessels moored at the dock which are not properly maintained and inspected by their owner or which, in the sole discretion of the owner or Harbormaster, present a threat to the health or safety of the public or the environment may be removed by the owner at the cost of the tenant. Reasonable notice depending on circumstances shall be given to the tenant prior to removal of the vessel.

DRAFT



BY _____

PART II: PUMPOUT COMPLIANCE

A) Pumpout Operations and Procedures

Tenants will be provided a copy of this O&M Plan which designates the location of the portable marine pumpout station located at the dock storage building adjacent to the community dock. Notice of Delaware pumpout regulations is provided on dock signage and the O&M Plan including penalties for noncompliance.

Pumpout Procedures:

1. Remove cap from the waste fitting on the boat;
2. Attach a suitable adapter to the dock fitting and hand tighten;
3. Place coupler over the adapter and lock;
4. Open valve;
5. Start pump;
6. If using a suction nozzle, insert it into the deck fitting (do not twist). Hold in place until pumpout is complete;
7. Observe pumpout through sight glass;
8. If rinse is desired, flush with fresh water (If potable water source is used for rinse, be certain that a back flow prevention device is installed on the water service line.);
9. Pump out rinse water. Close the valve and return hose and adapter;
10. Stop the pump.

Maintenance Procedures: Major maintenance procedures and winter storage are the responsibility of the dock operator. However, the following minimum maintenance will be required in all cases by individual users of pump station facilities:

1. Hoses should be flushed daily by pumping clean water through the system and emptying it into the disposal system. Never discharge flush water onto the ground or into the dock waters;
2. Disinfect the suction connection by dipping in bleach or spraying with a disinfectant after each use.

B) Number and Types of MSD's on Vessels

The number and types of MSD's aboard future vessels at the Oyster House Village Community Dock is unknown at this time. Records will be kept by the operator based upon future tenant agreements.

C) Pumpout Sharing Agreement

Since the Oyster House Village Community Dock will provide its own facilities, no pumpout agreements with other existing Docks have been made.

D) State of Delaware Pumpout Law

The State of Delaware laws pertaining to dock operations provide pumpout facilities and laws prohibiting the discharge of untreated or inadequately treated vessel sewage.

DRAFT

RECEIVED

State Law on Vessel Sewage Discharge

7 Delaware Code Chapter 60 § 6035

Vessel sewage discharge

- (a) Dock owners/operators for docks that are located in whole or in part on tidal waters of the State, and that provide dockage for vessels with a portable toilet(s) or Type III marine sanitation devise(s) (MSD), shall provide convenient access, as determined by the Department, in an approved, fully operable and well maintained pumpout facility(ies) and/or dump station(s) for the removal of sewage from said vessels to a Department approved sewage disposal system.
- (b) (1) Owners/operators may agree to pool resources for a single pumpout dump station with Departmental approval based on criteria of number and class of vessels, dock locations, cost per pumpout use, and ultimate method of sewage treatment and disposal (i.e., septic system or wastewater treatment facility).
- (2) The owner/operator of any boat docking facility that is located in whole or in part on tidal waters of the State, and that provides dockage for a live-aboard vessel(s) with a Type III marine sanitation device(s), shall install and maintain at all times, in a fully operable condition, an approved dedicated pumpout facility at each live-aboard vessel slip for the purpose of removing sewage from the live-aboard vessel on a continuous or automatic, intermittent basis to a Department (DNREC) approved sewage disposal system.
- (3) Any discharge, by any means, of untreated or inadequately treated vessel sewage into or upon the waters of any dock, boat docking facility or tidal water of the State is prohibited.
- (4) All vessels while on waters of the State shall comply with 33 U.S.C. § 1322, as amended February 4, 1987.
- (5) The Secretary shall have authority to adopt reasonable rules and regulations to implement this section.

DRAFT

RECEIVED
MAR 11 2019

BY: _____

PART III: STORMWATER MANAGEMENT

(A) Stormwater Management Practices/Plan

The Oyster House Village Community Dock strives to meet the needs of its recreational boating community while protecting the aquatic resources upon which they depend.

The Oyster House Village Community Dock does not contain any areas for major vessel maintenance or repairs, nor may these activities occur on the property. Such activities include bottom or hull painting, repairs, scraping or engine overhauls. Only minor maintenance such as washing, polishing and limited inboard painting are permitted to occur while vessels are moored. Any request for an exception to these prohibitions with just cause must be approved by the Harbormaster prior to conducting work. Appropriate measures for protecting water quality must be implemented prior to and during such work as directed by the Harbormaster or owner.

DRAFT

RECEIVED
MAR 13 2018

BY _____

PART IV: MATERIALS & WASTE MANAGEMENT

(A) Handling, Storage, and Disposal of Materials and Waste

Materials—A fueling facility is not located at the Dock.

All cleaning agents, solvents, paints, and pesticides utilized at the facility by the dock operator or his employees shall be safely stored in their original container in a covered storeroom or locker located at the community clubhouse or other appropriate location. Quantities of such materials shall be kept at a minimum. Privately-owned materials aboard vessels shall be kept at a minimum. Materials shall be kept secure in a covered area in original containers at all times.

Proper disposal of waste oil, oil absorbent sponges and similar materials are the responsibility of the tenants. Waste oil can be recycled at the nearest Delaware Solid Waste Authority (DSWA) recycling collection center.

Fish Waste—The Oyster House Village Community Dock does not contain an approved fish cleaning or fish waste recycling facility. Therefore, fish cleaning and disposal of fish wastes within the waters of the dock or the dock complex is prohibited. Residents and fishermen are encouraged to dispose of fish waste in accordance with DNREC's Fish Waste Management Policy as found at Part VI, C.

Other types of refuse shall be placed within private trash receptacles of residents. It shall be the responsibility of each resident to provide an appropriate trash removal schedule. Recycling of recyclable waste is encouraged.

Sanitary Wastes—Dock tenants and guests shall use the shore side bathroom facilities at all times when docked at the dock. No discharge of untreated or inadequately treated sewage is permitted within the dock or waters of the State under penalty of law. Sanitary waste from vessels shall be discharged at the dock pumpout station located on the community dock at the community clubhouse.

Bilge Water—Dock tenants are encouraged to use oil absorbent "sponges" in bilges at all times. Bilge water should not be pumped overboard in the dock but should be discharged at sea when possible. All vessels with automatic bilge pumps are requested to use absorbent sponges. Used sponges should be properly disposed of in the private trash receptacles of each resident.

DRAFT

PART V: EMERGENCY OPERATIONS

A) Responsible Personnel:

Oyster House Village Community Dock Harbormaster, Reg. Office No.: (484) 322-5440

Emergency Response Numbers:

Police/Fire/Ambulance	911
U.S. Coast Guard Search & Rescue	(757) 398-6700
DNREC Emergency Response Team/Dock Police	(800) 662-8802

In the event of a fuel, oil or sewage spill or fire, reporting contact numbers are:

Oyster House Village Community Dock Harbormaster	(484) 322-5440
Police/Medical/Fire Emergency	911
Local Fire Company – Rehoboth Beach Vol Fire Co.	(302) 227-8400
State Police (Non-emergency, Troop 7, Lewes, DE)	(302) 644-5020
U.S. Coast Guard (Indian River Inlet, DE)	(302) 227-2439
DNREC Emergency Response Team/Dock Police	(800) 662-8802
DNREC Inland Bays Pollution Reporting Hotline	(800) 523-3336
Sussex County Operations Center (severe weather)	(302) 855-7801

B) Fuel/Oil Spill Prevention and Containment Practices

Spills

Any dock patron who observes a spill should report it immediately to the dock Harbormaster or owner, DNREC and Coast Guard. Any dock tenant who causes or contributes to a spill of fuel, oil or other toxic substance should take immediate steps to:

1. Find and stop the cause of the spill.
2. Contain the spill if possible.
3. Report the spill to dock Harbormaster or owner, DNREC and the U.S. Coast Guard.

DRAFT

BY: _____
JUN 11 2019

An on-site spill containment kit and containment boom is stored in the community clubhouse in a storage building designated with a sign. Dock tenants are provided access information to this location.

4. In the event the spill cannot be quickly and readily contained, request immediate assistance from DNREC and the U.S. Coast Guard.
5. Properly dispose of all contaminated containment and clean-up materials.

C) Sewage Spill Prevention and Containment Practices

Community dock tenants shall be trained by the Harbormaster in the use of the community sewage pumpout system. Use of the pumpout system will be available during the normal operation during the boating season. Dock occupants will follow the pumpout procedures prescribed in Section II A of the O&M Plan.

D) Fire

It shall be the responsibility of all dock occupants with motorized vessels to maintain adequate onboard U.S. Coast Guard-approved fire extinguisher protection. An additional fire extinguisher is located at the community clubhouse. Each resident shall maintain an operable fire extinguisher at their home.

Any dock occupant who observes a fire which is not immediately contained with on-site equipment shall contact 911, and the Harbormaster and the owner.

E) Hurricane/Severe Weather

Community dock tenants and the Harbormaster shall keep advised of pending severe weather conditions. Information on emergency situations can be obtained from the Sussex County Operations Center, 302-855-7801. In the case of impending severe weather, the following measures are the responsibility of each tenant.

Removal of the boat from the water and storage away from the water and out of harm's way if at all possible;

If the boat cannot be removed from the water, all portable fuel tanks, Compressed Natural Gas (CNG) or propane tanks from grills or stoves, porta-potties and other loose gear should be removed from the vessel, and the vessel must be properly secured using extra lines and fenders if warranted.

Upon inspection of moored vessels prior to a severe weather event and after an attempt to notify boat owners to take action; the Harbormaster shall have the discretion to move a vessel, add additional mooring lines, or under take other necessary measures to properly secure a vessel. It will be the responsibility of the boat owner to reimburse the cost of such actions to the HOA.

DRAFT

APR 10 2018
BY: _____

PART VI: MARINA RULES AND REGULATIONS AND GENERAL GUIDANCE

A) Dock Rules and Regulations for Boaters

1. Any vessel entering the waters of the Oyster House Village Community Dock or moored at the marina as a tenant or transient vessel along with the operator and owner of said vessels shall be subject to these rules, this DNREC-pending approval O&M Plan for the facility, DNREC marina and boating regulations, and U.S. Coast Guard regulations.
2. No person shall dock or anchor a vessel within the waters of the Dock complex or launch a vessel from the marina complex unless the owner/operator of the vessel has secured a share, rented or purchased a berth area as required for usage. Contracts for usage shall be at the discretion of the owners. A copy of this O&M Plan shall be provided to each homeowner within the marina.
3. Docking or launching of vessels will be only as directed and permitted by the owner or Harbormaster.
4. No major repair work shall take place aboard any vessel or within marina grounds except for unusual cause and as permitted by the Harbormaster or owner.
5. The marina does not contain any refueling facilities. Tenants refueling vessels shall do so only as specified by the marina O&M Plan, Part I,E.
6. No refuse, trash, oil or effluents shall be thrown or pumped overboard within the waters of the marina, channel approaches or other water of the State.
7. Disorderly conduct by a boat owner, his crew or guests is not permitted.
8. Safety precautions must be observed and complied with in all marina areas.
 - a. Swimming or diving is prohibited from all piers, docks, bulkheads and vessels within the marina waters.
 - b. Running or horseplay is prohibited on all piers, docks and bulkheads.
 - c. Use of barbecue grills or other type of portable open flame devices is prohibited in docks or vessels moored within the marina.
9. Fish cleaning is prohibited within the marina complex.
10. It is prohibited to throw or dump in the waters or on the grounds of the marina any fish remains, parts or pieces thereof. Recycling of fish waste shall be in accordance with State policies provided in the O&M Plan.
11. No person shall go aboard any vessel docked within the marina without the expressed permission of the owner or master of such vessel.

DRAFT

12. The dock and its surroundings are a “no wake” zone. Operate your vessels cautiously at all times.
13. Community dock tenants are responsible for maintaining the knowledge of and complying with emergency procedures for fuel spills, oil spills, fires, hurricane and severe weather as detailed in the O&M Plan.
14. Community dock tenants and patrons shall comply with the following marina policies and operation procedures.
15. Operate your vessel and conduct yourself in accordance with Oyster House Village Community Dock Clean Marina Boating Tips.

B) Oyster House Village Community Dock Clean Marina Boating Tips

For use around the Community Dock and while on the water anywhere.

Contain Trash

- Do not let trash get thrown or blown overboard.
- If trash blows overboard, retrieve it—consider it “crew-overboard” practice.
- Pack food in reusable containers.
- Buy products without plastic or excessive packaging—plastic is deadly to fish and birds.
- Do not toss cigarette butts overboard—they are made of plastic (cellulose acetate).

Recycle

- Recycle cans, glass, paper, plastic, newspaper, antifreeze, oil and batteries.
- Recycling facilities are located throughout the area.
- Bring used monofilament fishing line to recycling bins.

Fuel Cautiously

- The Oyster House Village Community Dock does not contain a refueling facility. Use proper containers and fuel carefully if carrying fuel onboard your vessel.
- Shut down engines during fueling.
- Do not smoke during refueling.
- Ventilate all spaces and check for gasoline vapors before starting engines.
- Do not use soaps or dispersants on spills.
- Remember, fuel expands as it warms up. If you fill your tank, fill it only 90 - 95 percent full to prevent expansion and spillage.
- Use the oil absorbent pads to capture back splash and vent line overflow during fueling.
- Add a fuel conditioner to your tank if you use your engine infrequently.

Control Oil in the Bilge

- Keep your engine well tuned—no leaking seals, gaskets or hoses.
- Place oil absorbent material or a bio-remediating bilge boom in the bilge.
- Place an oil absorbent pad under the engine.
- Replace oil absorbent materials regularly.
- Check fuel lines for damage—replace with alcohol resistant hoses.
- Secure fuel hoses to prevent chafing and leaks.

DRAFT

BY: _____

APR 13 2018

- Never discharge bilge water with a sheen—it is illegal.

Waste Oil

- Dispose of waste oil at recycling facility.
- Do not discharge waste oil into storm drains, the Marina lagoons, or waters of the State of Delaware.

Properly Dispose of Oil Absorbent Materials

- If the pad is saturated with gas, allow it to air dry. Reuse.
- If the pad is saturated with diesel or oil, double bag it in plastic—one bag sealed inside another. Dispose in your regular trash.
- Bio-remediating bilge booms should not be sealed in plastic bags—the microbes need oxygen to function. Discard in regular trash or marina dumpster.

Clean Gently

- Be environmentally-aware.
- Wash your boat frequently with a sponge and plain water.
- Use detergents sparingly.
- Use phosphate-free, biodegradable and non-toxic cleaners.
- Wax your boat—a good coat of wax prevents surface dirt from becoming ingrained.
- Clean wood with a mild soap powder and a nylon brush—not harsh chemical cleaners.
- Conserve water—put a spray nozzle on your hose.

Maintain Your Vessel Wisely

- Major boat maintenance and repair are not permitted at the Oyster House Village Community Marina.

Sewage Pumpout & Management

- Never discharge any sewage into the waters of the Oyster House Village Community Marina.
- Never discharge raw or inadequately treated sewage in Delaware waters within three miles of shore.
- Use restrooms on shore.
- Under way, use approved Marine Sanitation Devices (MSD's).
- Establish regular maintenance schedule for your MSD based on manufacturer's recommendations.
- Pump out and rinse holding tanks regularly.
- Use pumpout station located at the Dock storage building adjacent to the community clubhouse.
- Use enzyme based products to control odor and reduce solids in holding tanks.
- Avoid holding tank products that contain quaternary ammonium compounds (QAC) and formaldehyde.

Dispose of Fish Waste Properly

- Fishing, crabbing and netting fish are not permitted on the marina docks.
- Do not clean fish within the marina basin.
- Do not discharge fish waste at the marina.
- Follow DNREC's Fish Waste Management policy.

DRAFT

BY: _____

Protect Sensitive Habitat

- Proceed slowly in shallow areas.
- Do not disturb wildlife.
- Avoid contact with submerged aquatic vegetation (SAV).
- Watch your wake—it can lead to shoreline erosion and disturb wildlife.

Be a Responsible Boater

- Contact the Harbormaster in the event of any emergency.
- Have a hurricane/storm plan.
- Learn about products and practices which are environmentally safe.
- Share the information with other boaters.
- Help guests understand that, on your boat, no trash is thrown overboard.
- Obey laws governing speeding, littering and discharge.
- Encourage other boating facilities to provide trash cans, recycling bins and pumpout stations.
- Support Marinas that are environmentally responsible.
- Note the location of fire extinguishers at your home and the Marina.

Be a Good Neighbor

- Be a responsible boater.
- Conserve water and electricity.
- Make sure your boat is secure to the dock at all times.
- Keep your pets on a leash no longer than 6 feet and under control at all times.
- Clean up after your pets.
- Supervise children at all times.
- Do not affix anything to the docks without the homeowners association (HOA) approval.
- Do not affix anything to the power posts, including electric cords and/or garden hoses.
- Use carts to transport items to and from your boat instead of dragging items along the surface of the docks.
- Be aware of the location of safety ladders and life ring stations.
- Throw a Personal Flotation Device to a person who has fallen overboard rather than attempt to swim to the person.

Enjoy!

DRAFT

APR 11 2013
BY: _____

C) State of Delaware Fish Waste Policy

FISH WASTE MANAGEMENT POLICY (No. 90-01)

Purpose

The purpose of this policy is to encourage the recycling of fish wastes back into the natural ecosystem in a manner that will not degrade water quality or cause other adverse environmental impacts. Any fish wastes which are recycled back into the ecosystem in accordance with the guidelines established below shall not be considered to be a discharge requiring a permit from the Department.

Background

Because of the potential for fish wastes which are improperly managed to cause dissolved oxygen depressions and other adverse environmental effects, as well as odors and nuisances, DNREC has developed a policy regarding their management.

DRAFT

RECEIVED
APR 10 2018

Application

The policy will be implemented in both fresh and tidal waters and will apply to:

- All private individuals who harvest fish or shellfish for recreational purposes, or for private use or consumption;
- Commercial fishermen;
- Head and charter boat owners and operators;
- Bait Concessions

Authority

The Department's (DNREC) Marina Regulations state that fish wastes must be disposed of in accordance with 7 Delaware Code, Chapter 60. Fish wastes (carcasses, entrails, scales, etc.) are included in the definition of "solid waste" and are a "pollutant" as defined in Chapter 60. In accordance with 56003, a permit is required to discharge these wastes into any surface or ground water. However, the purpose of this policy, as stated above, is to allow fish wastes to be recycled back into the ecosystem without a permit from the Department as long as the guidelines established below are adhered to. Those who do not follow established guidelines will be subject to fines and penalties as provided in 7 Del. C. §6005 and/or §6013.

Guidelines

In order to implement this policy in a manner consistent with the purpose stated above, the following guidelines are hereby established:

1. In order to prevent violations of the Delaware Surface Water Quality Standards, fish wastes should not be discharged into surface waters in any dead end lagoons or other poorly flushed locations. A dead end lagoon shall mean an enclosed embayment with only one opening. A recommended best management practice is to discharge on outgoing tides.
2. Fish wastes should be recycled back into the ecosystem from which the organisms were originally harvested.
3. Collected fish wastes should be handled in such a manner so as not to introduce other contaminants into the waste prior to recycling back into the ecosystem
4. Fish should be cleaned and uncontaminated fish wastes disposed of at sea whenever practicable.
5. Fish waste recycling within marina basins shall only be allowed if in accordance with an Operations and Maintenance Plan which has been approved by the Department. Marinas shall not provide fish cleaning stations unless the activity has been included in the Operations and Maintenance Plan. Marinas which are not approved for fish waste recycling shall post signs warning fishermen that it is unlawful to dispose of fish wastes into the water at that location. The Department will consider the flushing characteristics of the marina basin when determining whether or not to approve fish recycling at that location.
6. Fish wastes should not be recycled into surface waters in such a way that they will wash up onto any shoreline, or cause odors or other nuisances.
7. Oyster shells may be discharged into the waters of the State in accordance with Shellfish Management Programs, 7 Del. Code Chapter 19-12.

DRAFT

BY: _____

APPENDIX A

PROJECT PLANS

DRAFT

Legend

- Oyster House Village
- Parcels
- Streets
- 2005 Sussex County LIDAR - Elevation
- USFWS NWI
- 2007 DE Wetlands
- SOIL SURVEY
- orthos2012



1 inch = 100 feet
 0 50 100 Feet

MAPPED SITE RESOURCES
 APR 10 2018
DRAFT

OYSTER HOUSE VILLAGE
 REHOBOTH BEACH, DELAWARE
 SUSSEX COUNTY

ERI ENVIRONMENTAL
 RESOURCES, INC.

Date: 2/28/2017
 Revisions:

Dwn.By: JLW
 Proj.No.:

FIGURE:
3

Legend

Oyster House Village

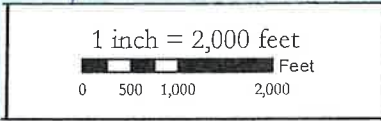

U.S. GEOLOGICAL SURVEY
TOPOGRAPHIC MAP
REHOBOTH BEACH QUAD.

solutions
Integrated Planning
Engineering & Management, LLC

303 North Bedford Street
Georgetown, DE 19947
T. 302.297.9215
www.solutionsipem.com
Copyright © 2018

PROPOSED COMMUNITY DOCK
AT
OYSTER HOUSE VILLAGE

DRAFT
APR 1 2018

TAX MAP 334-19.00-173.00
LEWES REHOBOTH HUNDRED
SUSSEX COUNTY, DELAWARE

FEBRUARY 14, 2018

SCALE: N.T.S.

SHEET 1 OF 7

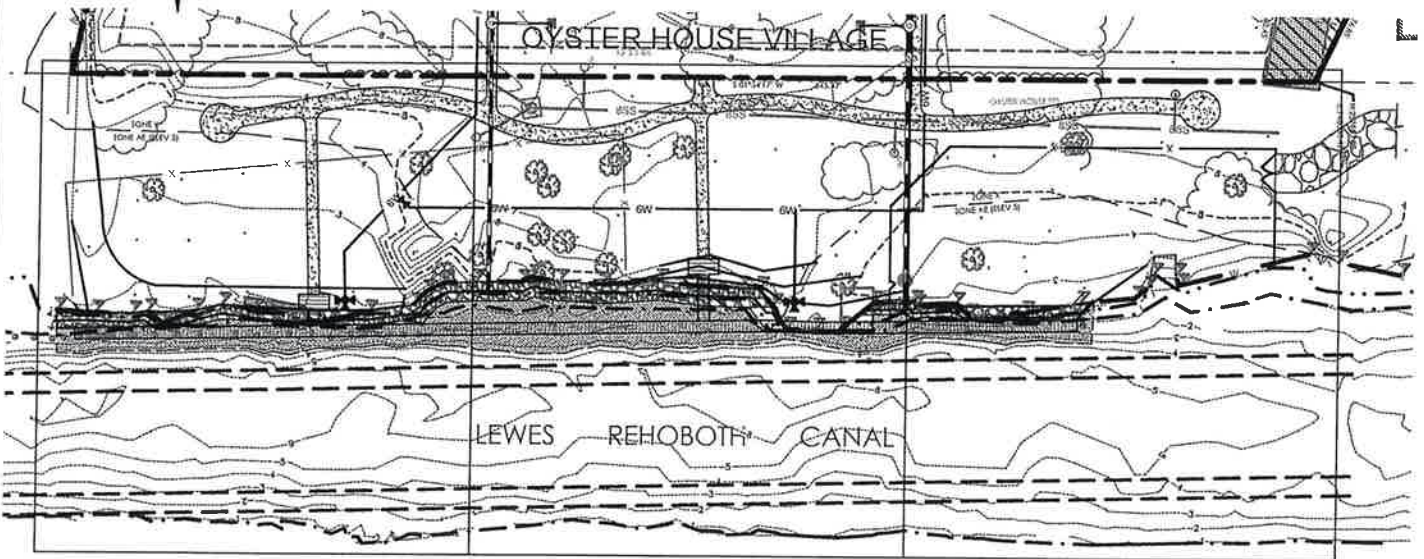

SHEET 3

SHEET 4

SHEET 5

IMPACT TABLE

KEY MAP

PROPOSED STRUCTURES

PROPOSED 6' WIDE DOCK	= 540 L.F.±
PROPOSED ACCESS PIERS OVER WATER	= 17 L.F.±
MAXIMUM NUMBER OF VESSELS	= 20

PROPOSED RIPRAP FILL AREAS IN WATERS OF THE U.S.

ABOVE MEAN HIGH WATER	= 2,230 S.F.±
MEAN HIGH WATER TO MEAN LOW WATER	= 1,800 S.F.±
CHANNELWARD OF MEAN LOW WATER	= 30 S.F.±

DREDGE QUANTITIES

AREA OF PROPOSED DREDGING	= 7,275 S.F.±
VOLUME OF PROPOSED DREDGING	= 300 C.Y.±

LEGEND

EXISTING	
PROPERTY LINE	
BOUNDARY OF WATERS OF THE U.S.	
MEAN HIGH WATER	
MEAN LOW WATER	
FEDERAL CHANNEL	
SALTMARSH GRASS	
SPOT ELEVATION	* 2.72

EXISTING	PROPOSED
CONTOUR	
FENCE	
TREE	
DOCK / PIER	
GRAVEL ACCESS DRIVE	
PATH	
RIPRAP BANK	
LIMITS OF DREDGING	
STORMDRAIN OUTFALL PIPE	

KEY MAP & IMPACT TABLE

DRAFT

PROPOSED COMMUNITY DOCK

AT

OYSTER HOUSE VILLAGE

TAX MAP 334-19.00-173.00
LEWES REHOBOTH HUNDRED
SUSSEX COUNTY, DELAWARE

APR 10 2018

FEBRUARY 14, 2018

SCALE: 1"=100'

SHEET 2 OF 7

solutions
Integrated Planning
Engineering & Management, LLC

303 North Bedford Street
Georgetown, DE 19947
T. 302.297.9215
www.solutionsipem.com
Copyright © 2018

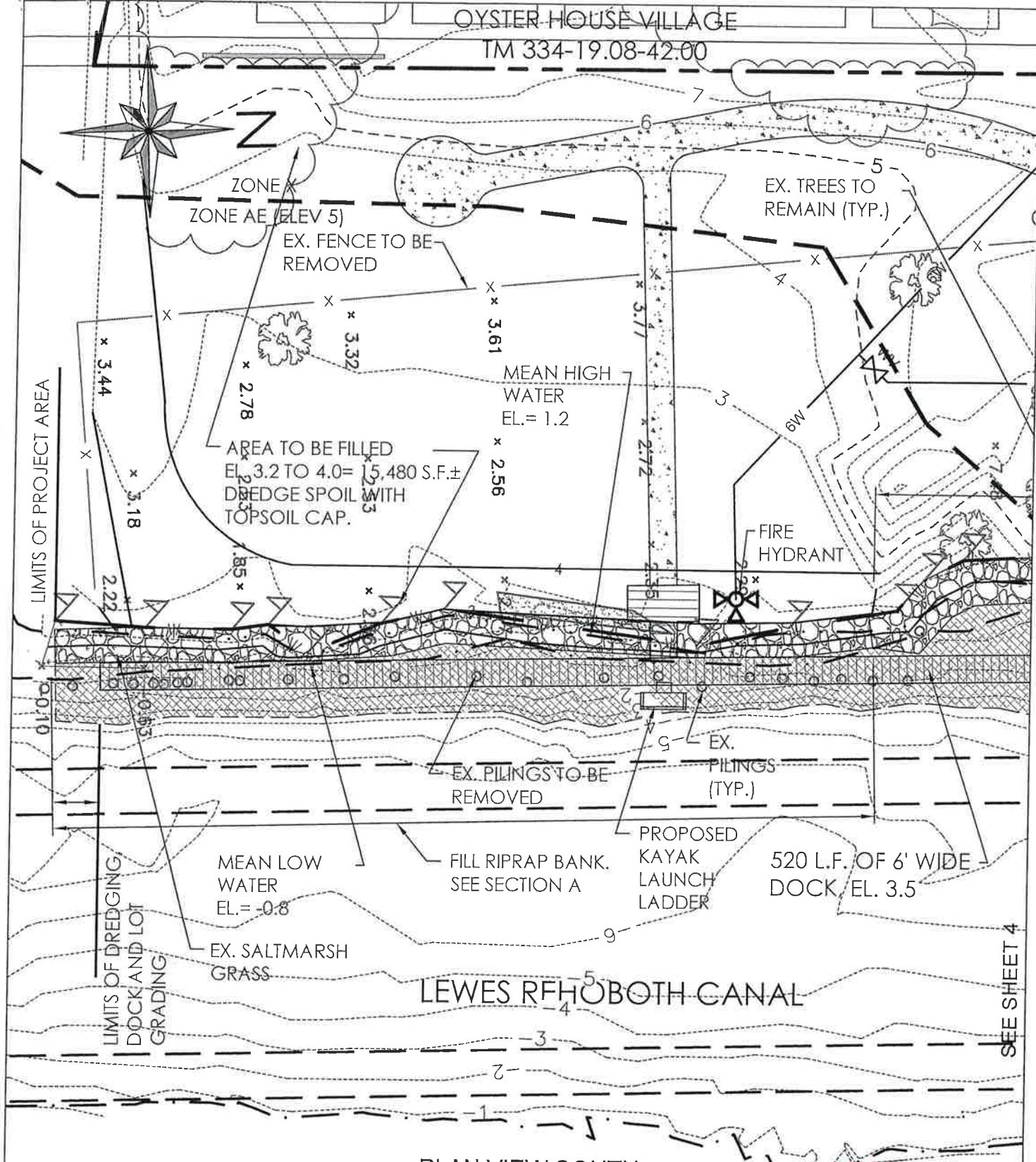

LIMITS OF PROJECT AREA

LIMITS OF DREDGING DOCK AND LOT GRADING

SEE SHEET 4

DRAFT

solutions
 Integrated Planning
 Engineering & Management, LLC

303 North Bedford Street
 Georgetown, DE 19947
 T. 302.297.9215
 www.solutionsipem.com
 Copyright © 2018

PROPOSED COMMUNITY DOCK
 AT
 OYSTER HOUSE VILLAGE

APR 10 2018

TAX MAP 334-19.00-173.00
 LEWES REHOBOTH HUNDRED
 SUSSEX COUNTY, DELAWARE

FEBRUARY 14, 2018

SCALE: 1"=30'

SHEET 3 OF 7

OYSTER HOUSE VILLAGE

TM 334-19.08-42.00

S 01°54'17" W 645.47'

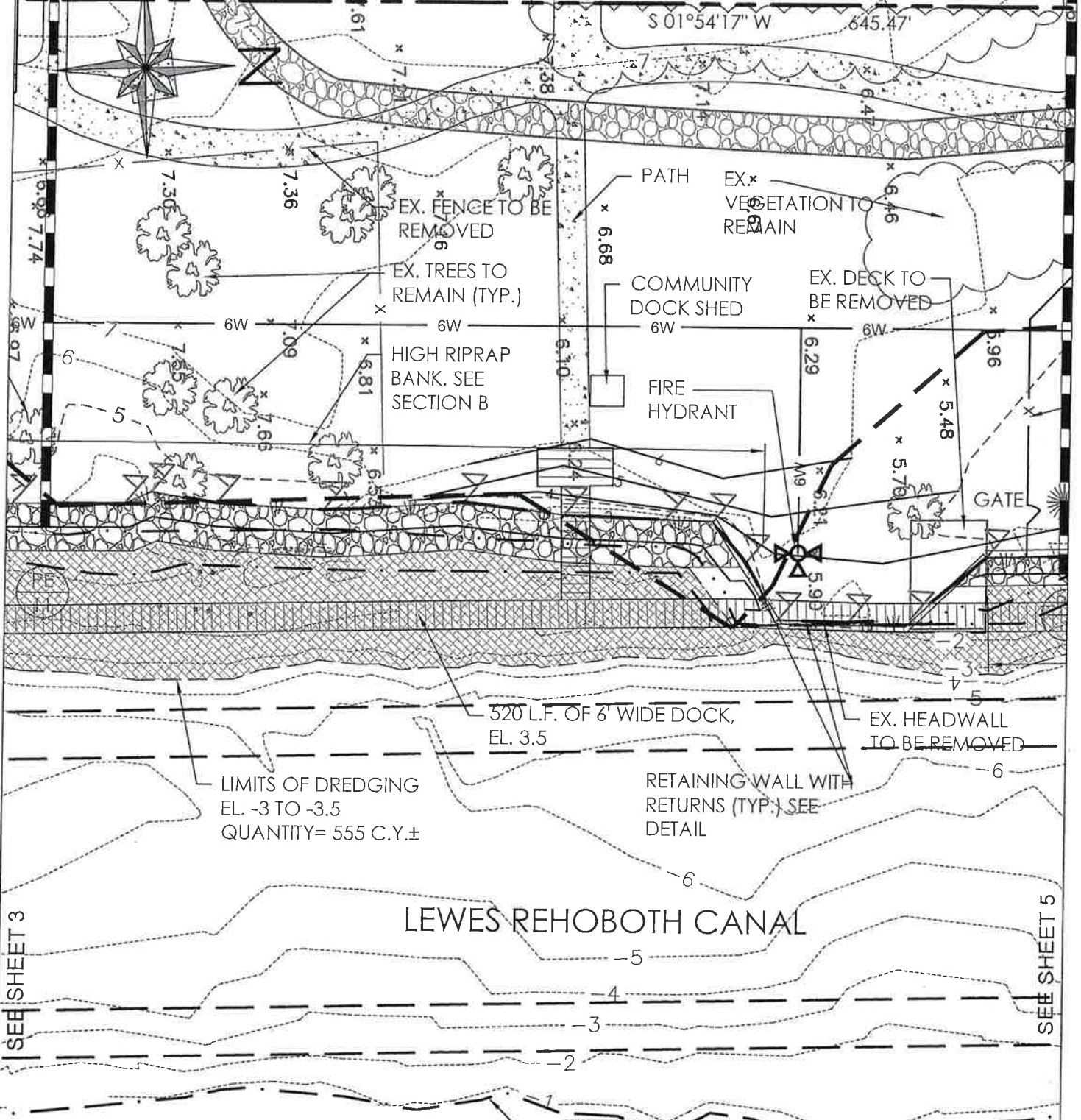
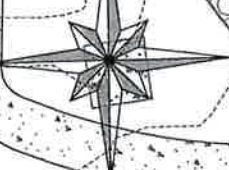

LEWES REHOBOTH CANAL

PLAN VIEW CENTER

PROPOSED COMMUNITY DOCK

AT OYSTER HOUSE VILLAGE

TAX MAP 334-19.00-173.00
LEWES REHOBOTH HUNDRED
SUSSEX COUNTY, DELAWARE

FEBRUARY 14, 2018

SCALE: 1"=30'

DRAFT

APR 10 2018

SHEET 4 OF 7

solutions
Integrated Planning
Engineering & Management, LLC

303 North Bedford Street
Georgetown, DE 19947
T. 302.297.9215
www.solutionsipem.com
Copyright © 2018

OYSTER HOUSE VILLAGE

TM 334-19.08-42.00

27.43

OYSTER HOUSE RD

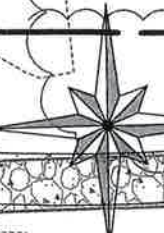

EX. EASEMENT 3
PERMANENT EASEMENT
DB 4554/275

GATE

LIMITS OF PROJECT
AREA

ZONE X
ZONE Y (ELEV 5)

FUTURE DNREC WATERWAY
MANAGEMENT COMPOUND

EX. PILING
TO BE
REMOVED

EX. BOAT
RAMP

10' CHANNEL BUFFER

LOW RIPRAP
BANK. SEE
SECTION C

LIMIT OF DOCK
LIMITS OF DREDGING

EXISTING FEDERAL
CHANNEL

LEWES REHOBOTH CANAL

10' CHANNEL BUFFER

PLAN VIEW NORTH

DRAFT

PROPOSED COMMUNITY DOCK

AT

OYSTER HOUSE VILLAGE

APR 10 2018

TAX MAP 334-19.00-173.00
LEWES REHOBOTH HUNDRED
SUSSEX COUNTY, DELAWARE

FEBRUARY 14, 2018

SCALE: 1"=30'

SHEET 5 OF 7

solutions

Integrated Planning
Engineering & Management, LLC

303 North Bedford Street
Georgetown, DE 19947
T. 302.297.9215
www.solutionsipem.com
Copyright © 2018

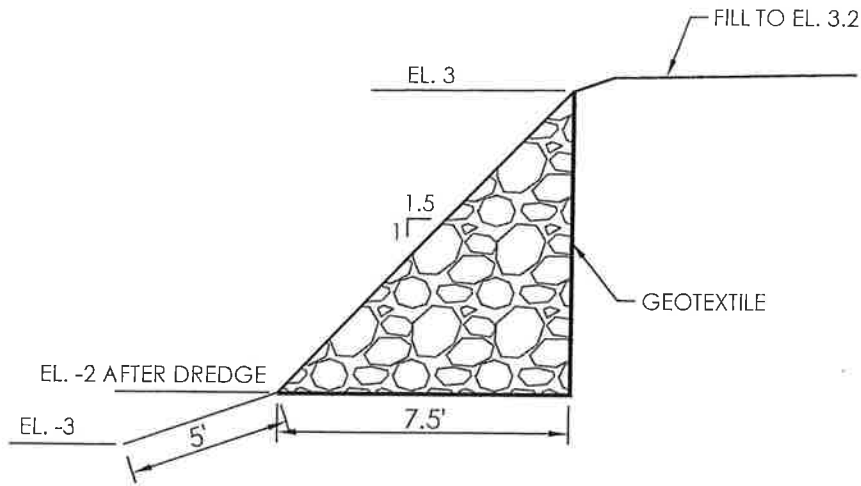

FILL RIPRAP BANK SECTION A
N.T.S.

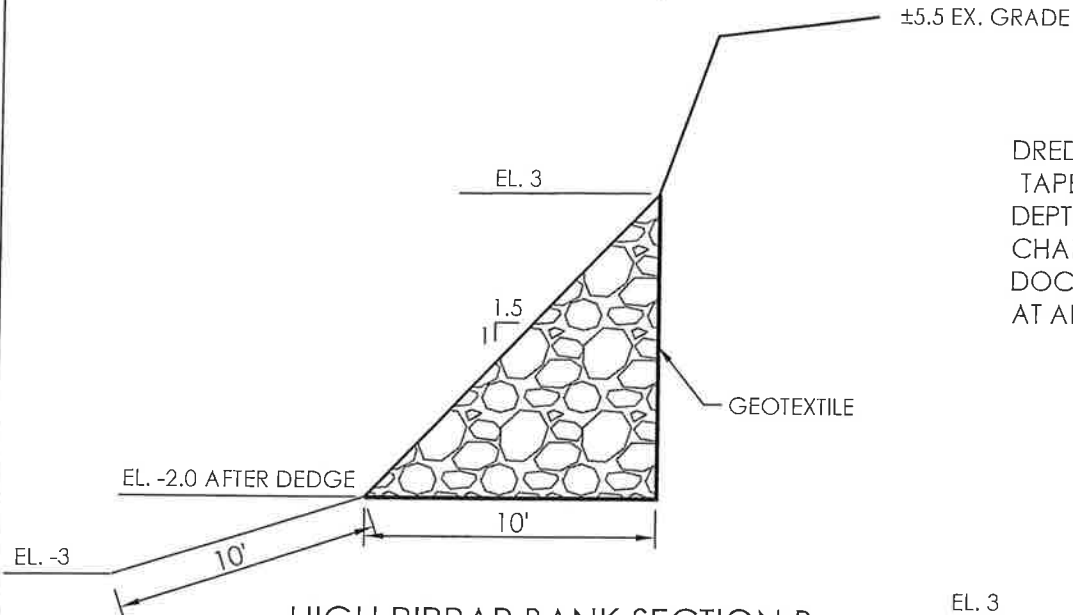

HIGH RIPRAP BANK SECTION B
N.T.S.

DREDGING NOTE:
TAPER TO PROVIDE
DEPTH OF -3.5 FEET
CHANNELWARD OF
DOCK WHERE POSSIBLE
AT ALL LOCATIONS.

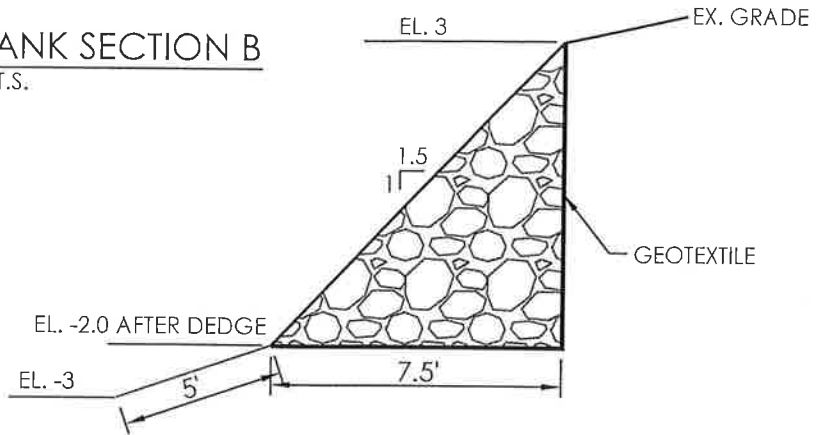

LOW RIPRAP BANK SECTION C
N.T.S.

DRAFT

**PROPOSED COMMUNITY DOCK
AT
OYSTER HOUSE VILLAGE**

TAX MAP 334-19.00-173.00
LEWES REHOBOTH HUNDRED
SUSSEX COUNTY, DELAWARE

FEBRUARY 14, 2018

SCALE: N.T.S.

APR 10 2018

SHEET 6 OF 7

solutions
Integrated Planning
Engineering & Management, LLC

303 North Bedford Street
Georgetown, DE 19947
T. 302.297.9215
www.solutionsipem.com
Copyright © 2018

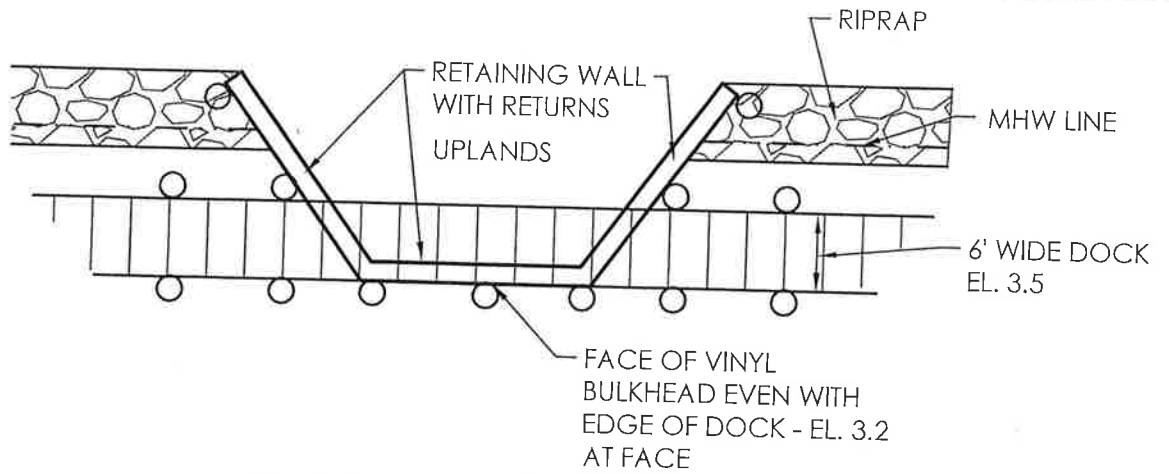

RETAINING WALL DETAIL
N.T.S.

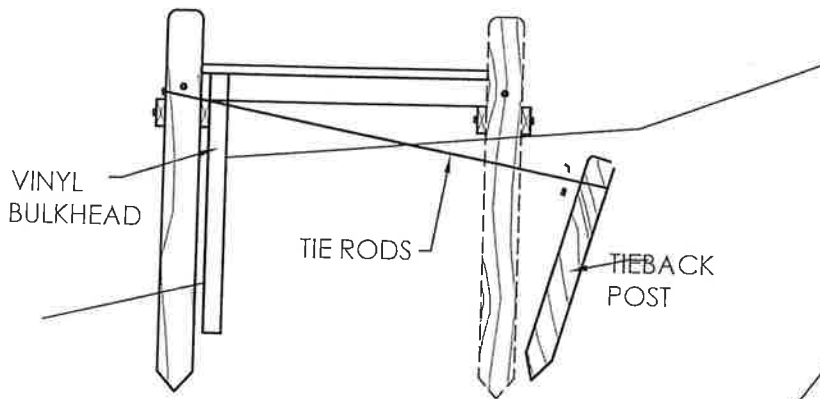

VINYL BULKHEAD DETAIL
N.T.S.

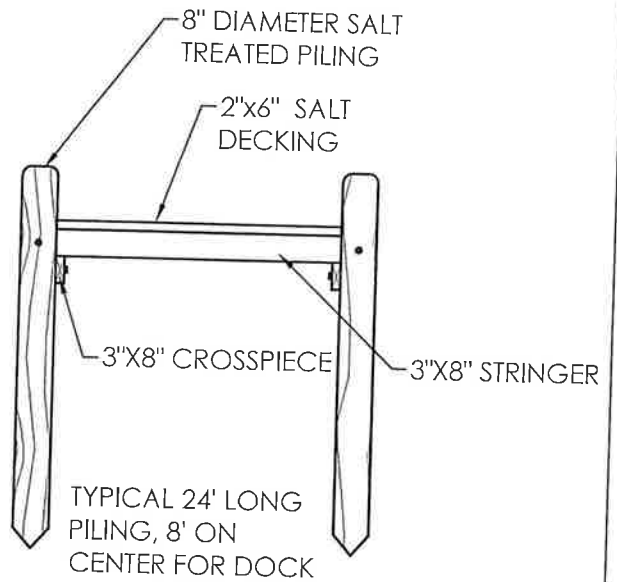

DOCK DETAIL
N.T.S.

DRAFT

solutions
Integrated Planning
Engineering & Management, LLC

303 North Bedford Street
Georgetown, DE 19947
T. 302.297.9215
www.solutionsipem.com
Copyright © 2018

PROPOSED COMMUNITY DOCK
AT
OYSTER HOUSE VILLAGE

APR 10 2018

TAX MAP 334-19.00-173.00
LEWES REHOBOTH HUNDRED
SUSSEX COUNTY, DELAWARE

[Handwritten signature]

FEBRUARY 14, 2018

SCALE: N.T.S.

SHEET 7 OF 7